



PROMOTION OF **COUNTER  
MEASURES** AGAINST  
**MARINE PLASTIC LITTER**  
IN SOUTH EAST ASIA AND  
INDIA

**REPORT**

**Desktop Review of Plastics  
and Plastic Pollution**

## Table of Contents

• Introduction.....	1
• Emergence of Plastics and its indicative range of applications .....	1
• The History / timeline of the plastics evolution .....	3
• Structure, properties and classification aspects concerning Plastics .....	4
• Categorisation of plastics .....	8
• The case of PET an insight on one of the categories.....	9
• Categorisation as Common and Specialised Plastic.....	16
• Additives and fillers in plastics and the issue of Toxicity .....	20
• The problem of Toxicity .....	23
• The properties and processing / production / fabrication and technology aspects with Plastics – An overview.....	24
• The processing / production / fabrication and technology aspects with Plastics – An outline.....	28
• Production of plastics: A comparison on Energy Benchmarks.....	38
• Plastics Composition, Application & Impacts.....	38
• The production and consumption of Plastics –Global trajectory .....	43
• The production and consumption of Plastics – Indian scenario.....	48
• Indicative Plastics Waste quantum and their variety in Electronics Waste and Auto Waste in India.....	60
• The potential for growth of polymers ahead in India .....	61
• Plastics Waste generation and Leakage in the Global context and the multidimensional pollution challenge .....	66
• The Plastic waste leakage perspective and plastic pollution in the marine environment.....	68
• Plastic Pollution – The estimates, impacts on marine biota and macro / micro distinction.....	70
• The distinction between macro - and micro – plastics and macro - and micro - debris .....	74
• Plastic Pollution & Its Impacts.....	77
• Impacts on Terrestrial Ecosystem.....	77
• The issue of mismanaged plastic waste.....	81
• Challenges of measuring of plastic pollution.....	86
• International efforts to check plastic waste generation .....	88
• Plastics Waste generation and management in the Indian context and significance of the study .....	89
• Summary of Implications of Plastic Pollution in Ganga Basin...97	

- A perspective regarding Plastic Waste Management Rules, in India and need for and indicative policy interventions arising .....98
- Responsibilities of CPCB.....102
- Responsibilities of Brand Owners, Producers and Importers (As per Rule 9).....102
- State Level Monitoring Committee (SLMC) for Monitoring of Implementation of PWM Rules, 2016 (As per Rule 16).....103
- The focus on Plastic Carry bags and Conditions for Plastic Bags.....103
- Plastic Management Strategies in India.....104
- Circular economy business models in plastics value chain and towards shaping innovative policies.....105
- Indicative Initiatives by Corporates / MNCs ..... 108
- Conclusion ..... 108

### List of Figure

S. No.	Title of figure	Page No.
1.1	The Materials domain.....	2
1.2	An outline of a polymer map.....	3
1.3	The process of polymerization via chain initiation, propagation and termination – The case of Poly ethylene or polythene.....	5
1.4	PET manufacturing outline.....	15
3.3	The Banbury mixer, used for the mixing of polymers and additives in the manufacture of plastic and rubber.....	29
3.4	Longitudinal section of a screw extruder of thermoplastic polymers.....	31
3.5	Blow extrusion of thermoplastic polymers	32

	.....	
<b>3.6</b>	Injection molding of thermoplastic polymers .....	34
<b>3.7</b>	Blow molding of plastic containers .....	36
<b>5.1</b>	Global Plastic Production trends .....	45
<b>5.2</b>	A reflection of various types of polymers production in Million Tonnes in year 2015 globally.....	46
<b>5.3</b>	Application of Oil and Gas resources for major domains in a global perspective.....	47
<b>5.4</b>	The usage of plastics across sectors globally (year 2015).....	48
<b>6.1</b>	Trend in production of key polymers in India in '000 Tonnes.....	49
<b>6.2</b>	Polymer wise consumption.....	50
<b>6.3</b>	a and b : Polymer wise consumption (Thermoplastics and Thermosetting type) (in Kilo Tonnes per Annum) in India in 2016-17..	51
<b>6.4</b>	Engineering Plastics Consumption in India in Kilo Tonnes in 2016-17.....	53
<b>6.5 a</b>	Sector wise consumption of Poly Ethylene and Poly Propylene in India during 2016-17.....	54
<b>6.5b</b>	Sector wise consumption of Poly Ethylene Terephthalate and Poly Vinyl Chloride in India during 2016-17.....	55
<b>6.5 c</b>	Plastics consumption by application in India.....	55
<b>6.6</b>	Polymer imports by India in 2016-17.....	56
<b>6.7</b>	Plastic Products exported by India in 2016-17 (PLASTINDIA Foundation)	58

<b>6.8a</b>	The region wise Plastic products exported by India in 2016-17 (PLASTINDIA Foundation) of USD 7.6 Billion	58
<b>6.8b</b>	Export of Polymers by India in 2016-17 (1362 Kilo Tonnes)	59
<b>7</b>	Indicative Plastics Waste quantum and their variety in Electronics Waste and Auto Waste in India	60
<b>9.1</b>	Waste Generation versus income level by country (UNEP, 2015)	67
<b>9.2</b>	Variation in MSW composition grouped by country income levels (UNEP, 2015)	67
<b>9.3</b>	An overview of plastic waste generation by industrial sector as of year 2015	68
<b>10.1</b>	The breakdown of produced plastics that have accumulated in the environment	69
<b>10.2</b>	Plastics waste leakage scenario	70
<b>11.1</b>	Oceanic Plastic Pollution (Source-Crédit Agricole)	71
<b>11.2</b>	Estimated Input of Plastic to the Oceans from top 20 Rivers	74
<b>15.1</b>	Regional contributions towards mismanaged plastic wastes as of year 2010	82
<b>15.2</b>	World map of estimated mass of mismanaged plastic wastes as of year 2010	83
<b>16.1</b>	A map of projected share of mismanaged plastic waste in 2025 in a geographical context	85
<b>18.1</b>	International regulatory developments concerning plastics and packaging	88
<b>19.1 a</b>	Plastic Waste generation levels vis a vis Total Municipal Solid Waste Generation in selected cities in Northern India	91
<b>19.1 b</b>	Plastic Waste generation levels vis a vis Total Municipal Solid Waste Generation in selected cities in Western India	92
<b>19.2</b>	Plastics packaging wastes in India (Mohanty, CIPET Presentation)	93
<b>19.3</b>	Plastics packaging wastes and recycling rates in India (Mohanty, CIPET Presentati	94
<b>21.1</b>	Progress on Plastic Waste Management Regulation in India	100
<b>22.1</b>	Nature of recycled plastic materials and products being developed in India (Mohanty, CIPET Presentation	105
<b>22.2</b>	Source : FICCI report, 2019 "Making Plastics Circular	105

## List of Tables

S. No.	Title of Table	Page No.
1.1	Seven Categories of Plastics	8
2.1	A list Of key Synthetic Polymers and their properties and Uses	17
2.2	Additives in five common polymers indicating their function and relative proportion	22
3.1	Key physico – chemical properties of plastics	24
3.2	Tensile strength and flexural modulus of some polymers and polymer family and types	26
4.1	Typical applications by polymer, excluding fibres	38
4.2	Semi-synthetic Fibres and Films (types) Source, Chemical Process and Application	40
4.3	Additive Use in Polymers	41
4.4	Ranking of Selected Polymers Based on the Hazard Classification Component Monomers	41
4.5	Examples of common plastic additives, associated functions, potential effect and status under the Stockholm Convention	42
4.6	The estimated consumption of plastics across regions	45
6.1	Polymer Production in India in Kilo Tonnes per Annum (Plastindia Foundation)	48
6.3	High End Engineering Polymers Production in India by selected companies (PLASTINDIA Foundation)	53
6.4	Service Life of Plastic products (Reference CSE report and Nitin H. Mutha et al., 2006)	59
7.1	Composition of key materials in E-Waste	60
7.1 a	Indicative composition of Key materials in Auto Waste (Materials in End of Life Vehicles) as per Presentation	61

<b>S. No.</b>	<b>Title of Table</b>	<b>Page No.</b>
	by CIPET and citing	
7.1b	On average or indicative plastics in End of Life Vehicles as per Presentation by CIPET and citing	61
8.1	Plastic Parks - Existing and Proposed Geographic distribution (PlastIndia report)	62
8.2	A list of branded plastics	63
19.1	Plastics recycling rates in India (Mohanty, CIPET Presentation)	93
21.1	Important legislations regarding Plastic Waste Management in India	99
21	Some of the authorities and their responsibilities under PWM, 2016	100
22.1	Key Responsibilities of Central Pollution Control Board	102
22.2	Potential technology applications across the value chain (FICCI, 2019)	107
23.1	Corporate initiatives contributing to Plastic Waste management (Source FICCI report)	108
	<b>Annexure-1</b>	
1	Impact Matrix Uttarakhand	110
2	Impact Matrix Uttar Pradesh	110
3	Impact Matrix Bihar	111
4	Impact Matrix West Bengal	112

## **1.0 Introduction**

This chapter has been structured essentially in two parts. The initial part upto section 2.7 presents several key features of the science and technology and historical developments in the domain of plastics manufacturing, polymer development and applications. It also presents the growth and trends including quantum of trade in plastics in global and Indian context. The second part addresses the key insights into the problem of plastic waste generation, its mismanagement and emerging impacts both in global and Indian context. This includes, their distribution across various regions and media from the soil to the riverine and marine environment (as macro / micro plastics). Further, plastics have been identified to contribute to several problems and impacts to the fauna in particular, and the concern and problem of plastics finding their way into the food chain from lower to the higher trophic levels.

The chapter highlights the need for developing countermeasures in riverine and marine ecosystem including further studies to be undertaken in developing countries such as India, such as to explore the pattern and leakage scenario pertaining to plastics reaching riverine systems and further into oceans. The chapter serves as a guiding document to subsequent chapters and lead to reflections regarding countermeasures that are already in place to check plastic pollution, as well as those needed to be designed or implemented ahead.

### **1.1 Emergence of Plastics and its indicative range of applications**

Plastic, is a polymeric material that has the capability of being moulded or shaped, usually by the application of heat and pressure. This property of plasticity, often found in combination with other special properties such as low density, low electrical conductivity, transparency, and toughness, allows plastics to be made into a great variety of products. The plasticity, or malleability, of the material during manufacture allows it to be cast, pressed, or extruded into a variety of shapes, such as: films, fibers, plates, tubes, bottles, boxes, amongst many others. (Henry George Liddell et al., Etymonline.com)[1]. Plastics are typically organic polymers of high molecular mass and often contain other substances. They are usually synthetic, most commonly derived from petrochemicals, however, an array of variants are made from renewable materials such as polylactic acid from corn or cellulosic from cotton linters ([;https://en.wikipedia.org/wiki/Plastic](https://en.wikipedia.org/wiki/Plastic)).



It is emphasized that due to their low cost, ease of manufacture, versatility, and imperviousness to water, plastics are used in a multitude of products of different scale, which includes packaging of small to large quantities of materials, paper clips and staplers, to computer components and transport vehicles including cars to aircrafts to spacecraft and satellites etc. It has been estimated that in developed economies and in general on a global basis, about a third of plastic is used in packaging, besides a similar quantum in building materials related applications applications such as piping, plumbing or claddings and flooring and others such as vinyl siding. Other uses include automobiles (up to 20% plastic approximately), furniture, and toys etc. In developing countries, the applications of plastic may differ though, for example about 42% of India's consumption is used in packaging. It is reflected that on a global scale about 50 kg of plastic is produced annually per person, with a high growth rate whereby production is doubling every ten years (Andrady AL et al.)[2]. It has been recognized that the world's first fully synthetic plastic has been bakelite, as invented in New York in 1907, by Leo Baekeland who is also credited to coin the term 'plastics'. The domain of polymers and plastics has a niche in the material world as depicted in the Figure 1.1 below- Figure-1.1. also depicts composites being developed via interaction with other domains.

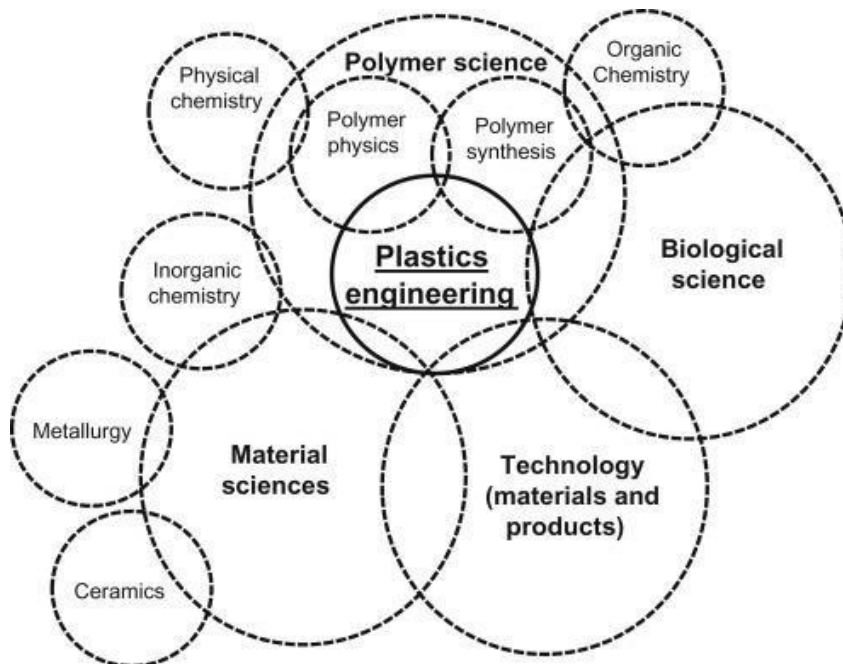


Figure 1.1: The Materials domain

The framework pertaining to Polymers has been mapped and showcased

for an overview of the key aspects as represented in Figure 1.2.

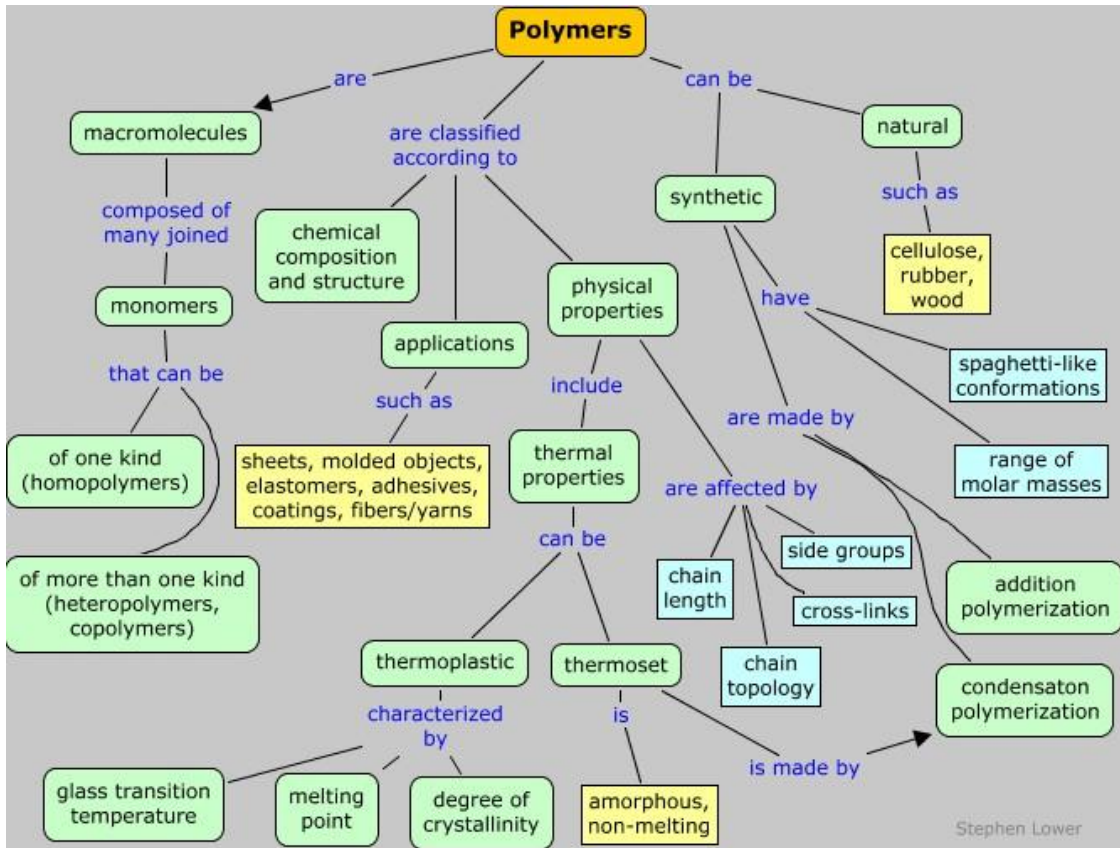


Figure 1.2: An outline of a polymer map

Source: <https://www.chem1.com/acad/webtext/states/polymers.html>

In the world economy today plastics are a key material at the heart of almost every industry and across product streams. Advancements and innovation in automotive, aerospace, medical, electronics, computer and other consumer products rely on plastics for their remarkable qualities.

## 1.2 The History / timeline of the plastics evolution

The progress on plastics related developments has evolved from the use of natural plastic materials (e.g., chewing gum, shellac) to the use of chemically created and or modified products from natural materials (e.g., natural rubber, nitrocellulose, collagen, galalite) and further to completely synthetic molecules (e.g., bakelite, epoxy, polyvinyl chloride) (<https://en.wikipedia.org/wiki/Plastic> 28 Feb, 2020). It has been indicated that the early stage plastics were bio-derived materials such as egg and

blood proteins, which are organic polymers. Infact a few centuries ago in around 1600 BC, Mesoamericans used natural rubber for making balls, bands, and figurines (Andrady A et.al.) [2]. Also in the middle ages it has been indicated that treated cattle horns were used in windows. Also materials that mimicked the properties of horns were developed by treating milk proteins (casein) with lye. The momentum had further gathered in the nineteenth century, as the field of industrial chemistry evolved as part of the Industrial Revolution, whereby new materials were created and informed and found applications. At this stage the development of plastics also accelerated with Charles Goodyear's discovery of vulcanization to thermoset materials derived from natural rubber.

In the context of synthesis and synthetics it is Parkesine (nitrocellulose) that is considered the first man-made plastic, which has been patented by Alexander Parkes, in Birmingham, England in 1856 (UK Patent office, 1857). As a process Parkesine was made from cellulose (the key component of plant cell walls) and treated with nitric acid as a solvent. The product from the process is commonly known as cellulose nitrate or pyroxilin, which could be dissolved in alcohol and hardened into a transparent and elastic material that could be molded when heated. Further into this by addition of suitable pigments a product could be made to resemble ivory. It is also indicated in literature that in the early 1900s, Bakelite, the first fully synthetic thermoset, was reported by Belgian chemist Leo Baekeland by using phenol and formaldehyde.

### **1.3 Structure, properties and classification aspects concerning Plastics**

It is highlighted that most plastics contain organic polymers and that the vast range of these polymers are formed from chains of carbon atoms, 'pure' or with the addition of: oxygen, nitrogen, or sulphur. These chains comprise many repeat units, formed from monomers and that each polymer chain can have several thousand repeating units. The backbone is the part of the chain that is on the "main path", linking together a large number of repeat units. Figure 1.3 reflects upon the process of chain growth and polymerization in the case of Polythene.

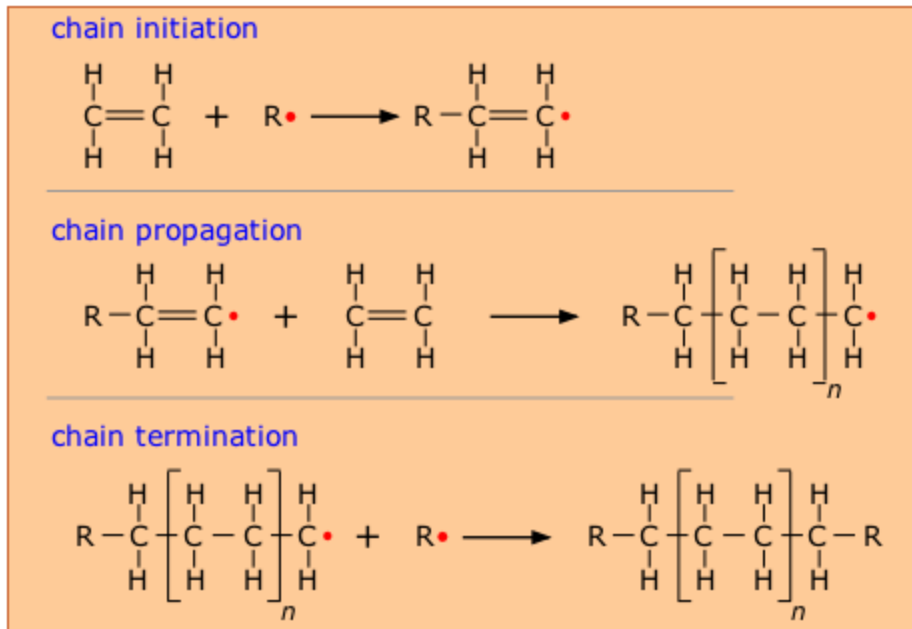


Figure 1.3: The process of polymerisation via chain initiation, propagation and termination – The case of Poly ethylene or polythene

It has been indicated that to customize the properties of a plastic, different molecular groups are made to connect or hang from the core backbone. These so called pendant units are linked or hung on the monomers, before the monomers themselves are enabled to be linked and joined together to form the polymer chain. It is emphasised that the structure of these side chains especially influence the properties of the polymer. Accordingly, the molecular structure of the repeating unit can be designed and tuned to influence specific properties of the polymer (Ebbin et al, 2016; General Chemistry. Cengage Learnin; <https://en.wikipedia.org/wiki/Plastic> accessed 28 Feb 2020).

The classification of plastics is usually undertaken by: the chemical structure of the polymer's backbone and side chains. It is indicated that some important groups in these classifications are: the acrylics, polyesters, silicones, polyurethanes, and halogenated plastics. Plastics can also be classified by: the chemical process used in their synthesis, such as: condensation, polyaddition, and cross-linking. Plastics can also be classified by: their various physical properties, such as: hardness, density, tensile strength, resistance to heat and glass transition temperature, and by their chemical properties, such as the organic chemistry of the polymer and its resistance and reaction to various chemical products and processes, such as: organic solvents, oxidation, and ionizing radiation. In particular, most

plastics will melt upon heating to a few hundred degrees celsius.[10] Other classifications are based on qualities that are relevant for manufacturing or product design. Examples of such qualities and classes are: thermoplastics and thermosets, conductive polymers, biodegradable plastics and engineering plastics and other plastics with particular structures, such as elastomers. (<https://en.wikipedia.org/wiki/Plastic> accessed 28 February 2020; Classification of Plastics Archived at the Wayback Machine. Dwb.unl.edu; Periodic Table of Polymers Dr Robin Kent – Tangram Technology Ltd.)

Plastics are generally categorized by the permanence or impermanence of their form into two types i.e. Thermoplastics and Thermosets. However, there are additional classification aspects and plastic types such as Amorphous plastics and crystalline plastics, Conductive polymers, Biodegradable plastics and bioplastics etc., and key features of these are as follows:

- Thermoplastics: Thermoplastics or Thermosoftening plastics are the plastics which soften on heating and can be molded into desired shape such as Polyethylene Terephthalate (PET), High Density Polyethylene (HDPE), Low Density Polyethylene (LDPE), Polypropylene (PP), Poly Vinyl Chloride (PVC), Polystyrene (PS), etc.
- Thermosets: Thermoset or thermosetting plastics on heating, cannot be remolded or recycled such as Sheet Molding Compounds (SMC), Fiber Reinforced Plastic (FRP), Bakelite etc. which are some of the examples.

### **Amorphous plastics and crystalline plastics**

It is indicated in the literature that many plastics are completely amorphous such as: all thermosets; polystyrene and its copolymers; and polymethyl methacrylate. However, some plastics are partially crystalline and partially amorphous in molecular structure, giving them both a melting point, the temperature at which the attractive intermolecular forces are overcome, and also one or more glass transitions, the temperatures above which the extent of localized molecular flexibility is substantially increased. These so-called semi-crystalline plastics include: polyethylene, polypropylene, polyvinyl chloride, polyamides (nylons), polyesters and some polyurethanes (Kutz, Myer, 2002).

## **Conductive polymers**

A range of polymers have been developed and more research ongoing about Intrinsically Conducting Polymers (ICP), which are organic polymers that conduct electricity. It is however emphasized that while plastics can be made electrically conductive, with a conductivity of up to 80 kS/cm in stretch-oriented polyacetylene, they are still far behind compared to most metals like copper which have a conductivity of several hundred kS/cm. However, this is a developing field. (Heeger, A.J et al 1988)

## **Biodegradable plastics**

Plastics that degrade, or break down, upon exposure to: sunlight or ultra-violet radiation, water or dampness, bacteria, enzymes or wind abrasion are known as biodegradable plastics. It is also indicated that in some instances, rodent, pest, or insect attack can also be considered as forms of biodegradation or environmental degradation. Some modes of degradation require that the plastic be exposed at the surface and exposed to the air / atmosphere and oxygen (aerobic), whereas other modes will only be effective if certain conditions exist in landfill or composting systems and prevented from exposure to air/oxygen etc (anaerobic). It is also indicated that biodegradable additives are also being manufactured by some companies / firms, to enhance the process and rate of biodegradation. Plastic can have starch powder added as a filler to allow it to degrade more easily, but this still does not lead to the complete breaking down of the plastic. Some researchers have genetically engineered bacteria to synthesize completely biodegradable plastics, such as Biopol (<https://en.wikipedia.org/wiki/Plastic> accessed 28 Feb 2020; Brandl, Helmut et al 1992).

## **Bioplastics**

Majority of the plastics are being produced from petrochemicals as a base, and that bioplastics are made substantially from renewable plant materials such as cellulose and starch. It is indicative that due both to the finite limits of the petrochemical reserves and to the threat of global warming, the development of bioplastics is turning out to be a growing field. In the circumstances however it is to be noted that





bioplastic development begins from a very low base and, as yet, does not compare significantly with petrochemical production. Estimates of the global production capacity for bio-derived materials is put at 327,000 tonnes/year. In contrast, global production of polyethylene (PE) and polypropylene (PP), the world's leading petrochemical derived polyolefins, was estimated at over 150 million tonnes in 2015 (<https://en.wikipedia.org/wiki/Plastic> accessed 28 February 2020; Galie, Fabrizi, 2016; and weblink "Global Market Trends and Investments in Polyethylene and Polypropylene" (PDF). ICIS Whitepaper. Reed business Information, Inc.).




## 1.4 Categorisation of plastics

### Seven categories of plastics

Based on the characteristics and usage of plastics, they are being classified under the following 7 categories and sought to be labeled accordingly:

Table 1.1: Seven Categories of Plastics

S. No.	Symbol	Short Name	Scientific Name	Uses
1		PET	Polyethylene terephthalate	Mineral water/Soft drink bottles, food jars, carpet, plastic films / sheets paneling etc.
2		HDPE	High-density polyethylene	Shampoo Bottles, carry bags, milk pouches, recycling bins, woven sacks agricultural pipe, base cups, playground equipment etc.
3		PVC	Polyvinyl chloride	Pipe, Window profile, fencing, hoses, flooring, shower curtains, wire, cable insulations, lawn chairs, non-food bottles and children's toys etc.
4		LDPE	Low-density polyethylene	Plastic carry bags, plastic wraps; coatings for paper milk cartons and hot & cold beverage cups, dispensing bottles, wash bottles, tubing etc.

5		PP	Polypropylene	Auto parts, industrial fibers, disposable cups, bottle caps, straws, food containers, dishware etc.
6		PS	Polystyrene	Cafeteria trays, CD covers plastic utensils, toys, video cassettes and cases, clamshell containers, insulation board etc.
7		O	Other, Poly carbonate, Poly urethane (PU), FRP	Thermoset Plastics, Multilayer and Laminates, Bakelite, Melamine plates, Helmets, shoe soles, Nylon SMC, etc.

## 1.5 The case of PET an insight on one of the categories

### (a) The key features of PET

Polyethylene terephthalate (PET or PETE) is a general-purpose thermoplastic polymer which belongs to the polyester family of polymers. Polyester resins are known for their excellent combination of properties such as mechanical, thermal, chemical resistance as well as dimensional stability (<https://omnexus.specialchem.com/selection-guide/polyethylene-terephthalate-pet-lastic> accessed 13 March 2020)

In the case of PET it is indicated that recycled PET can be converted to fibers, fabrics and sheets for making packaging and manufacturing automotive parts. From chemistry perspective

Polyethylene Terephthalate is significantly similar to

[astic"PolybutyleneHYPERLINK](#)

["https://omnexus.specialchem.com/selection-guide/polybutyl](https://omnexus.specialchem.com/selection-guide/polybutyl)

Terephthalate. In respect of its properties PET is highly flexible, colourless and semi-crystalline resin in its natural state. Further, depending upon how it is processed, it can emerge as semi-rigid to rigid. Another set of key features of PET is that it presents good dimensional stability, resistance to impact, moisture, alcohols and solvents. There is a range of commercially available PET grades, which include un-reinforced to glass reinforced, flame retardant and



high flow materials for various engineering applications that typically require higher strength and or higher heat resistance. Addition of fillers like glass fibers, CNTs etc. help improve impact strength, surface finish, reduce warpage and several other benefits (<https://omnexus.specialchem.com/selection-guide/polyethylene-terephthalate-pet-plastic> accessed 13 March 2020).

### **(b) PET Copolymers**

It is emphasised that PET is available as a homopolymer and it can also be modified to produce copolymers (known as PETG or PET-G - polyethylene terephthalate glycol-modified) making it more desirable for a particular application. Further, the common modifiers which replace ethylene glycol or terephthalic acid to produce PETG are cyclohexane dimethanol (CHDM) and isophthalic acid respectively. It is assessed that these modifiers interfere with crystallization and lowers the polymer's melting temperature.

### **(c) Advantages & Key Properties of PET Resin**

(<https://omnexus.specialchem.com/selection-guide/polyethylene-terephthalate-pet-plastic> accessed 13 March 2020).

The major advantages and key properties of the PET resin are further enumerated below:

- It has higher strength and stiffness than PBT (Poly Butylene Terephthalate)
- It is very strong and lightweight & hence easy and efficient to transport
- It is known for its good gas (oxygen, carbon dioxide) and moisture barrier properties
- It exhibits excellent electrical insulating properties
- PET has broad range of use temperature, from -60 to 130°C
- As compared to PBT, it also has higher heat distortion temperature (HDT)
- It has low gas permeability, in particularly with carbon dioxide
- PET is suitable for transparent applications, when quenching during processing

- PET doesn't not break or fracture. It is practically shatter-resistant and hence, a suitable glass-replacement in some applications
- It is recyclable and transparent to microwave radiation
- PET is approved as safe for contact with foods and beverages by the FDA, Health Canada, EFSA & other health agencies

### **(i) The Chemical Properties of PET**

The key chemical properties of PET are:-

- Excellent resistance to alcohols, aliphatic hydrocarbons, oils, greases and diluted acids
- Moderate resistance to diluted alkalis, aromatic & halogenated hydrocarbons

There are however certain limitations as well of PET (especially in case of comparison with PBT) such as :-

- Lower impact strength than PBT
- Lower moldability than PBT, due its slow crystallization rate
- Affected by boiling water
- Attacked by alkalis and strong bases
- Attacked at high temperatures (>60°C) by ketones, aromatic and chlorinated hydrocarbons and diluted acids and bases
- Poor burning behaviour

### **(d) Blending of PET with Thermoplastics and Thermosets**

Blending of PET with other thermoplastics or thermosets is done to tailor new materials having improved performance with beneficial cost profiles to meet specific application demands. Blending also opens up new markets and applications potential without much investment and development. The thermoplastic polymers that are used to produce blends with PET are polyethylene, polypropylene, polycarbonates, polystyrene, ethyl vinyl acetate and Acrylonitrile Butadiene Styrene. Further, the key thermosets used to produce PET blends include epoxies, polyester resins, phenolic resins, elastomers such as nitrile butadiene rubber, styrene butadiene rubber etc.

### **(e) The major applications and use of PET**

Some of the important applications of PET include

- Several packaging applications, such as :
- In view of Polyethylene Terephthalate being an exceedingly good water and moisture barrier material, plastic bottles made from PET are widely used for mineral water and carbonated soft drinks
- The significant mechanical strength, makes Polyethylene Terephthalate films ideal for use in tape applications
- Further, non-oriented PET sheet can be thermoformed to make packaging trays and blisters
- Due to chemical inertness properties, together with other physical properties, it has been found especially suitable for food packaging applications
- In addition are packaging applications which include rigid cosmetic jars, microwavable containers, transparent films, etc.
- The PET monofilament is mainly used for making mesh fabrics for screen- printing, filter for oil and sand filtration, bracing wires for agricultural applications (greenhouses etc.), woven/knitting belt, filter cloth, and other such industrial applications.
- It has wide applications in textile industry. It is to be noted that polyester fabrics are strong, flexible, and offer additional benefit of less wrinkles and shrinkage over cotton. Polyester fabrics are light-weight, achieve reduced- wind flux, are drag-resistant and more resistant to tears.
- Further, in view of good electrical insulating properties, high structural and dimensional stability, polyethylene terephthalate is widely used in electrical and electronics industry. It is an effective polymer to replace die cast metals and thermosets in applications like: electrical encapsulation, solenoids, smart meters, photovoltaic parts, solar junction boxes, etc. This polymer's excellent flow characteristics enable design freedom and miniaturization to produce high-performance parts.
- Further, it is being used in many applications in the automotive industry and sector. It is especially being used for wiper arm and gear housings, headlamp retainer, engine cover, connector housings etc.

### **(f) The making of PET**

It is aliphatic polyester and it is obtained from polycondensation reaction of the monomers obtained either by:

- Esterification reaction between terephthalic acid and ethylene glycol, OR
- Trans-esterification reaction between ethylene glycol and dimethyl terephthalate

### **(g) The processing conditions for PET and key methods to utilise the polymer**

It is indicative that PET can be easily processed by injection molding, extrusion, blow moulding and thermoforming. It is generally extruded to produce films and sheets (which can be thermoformed later) and by blow molding it is especially used to produce transparent bottles. Further, it is recommended to dry Polyethylene terephthalate for 2-4 hours at 120°C before processing and that upto 25% regrind can be utilised. It is indicated here that graphic and / or schematic details of some of the processes indicated here is reflected in another section of the chapter.

#### **(i) Blow Molding**

- Blow molding process and technique is generally used to produce transparent bottles
- Here mold temperature should lie between 10 and 50°C

#### **(ii) Injection Molding**

- For injection molding Melt temperature to be maintained is 280-310°C
- Further, Mold temperature is maintained between 140-160°C to obtain a crystalline PET (for technical applications)
- In the case of transparent applications, mold temperature should lie between 10 and 50°C
- Also screw with an L/D ratio of 18-22 is recommended

#### **(iii) Extrusion**

- PET is generally extruded to produce films and sheets (can be thermoformed later)

- The extrusion temperature is maintained between 270-290°C

#### **(iv) 3D printing**

It is important to note that PET is an optimum polymer to produce 3D <https://omnexus.specialchem.com/channel/3d-printing> Printed objects having high flexibility and toughness. Certain modified PET compounds have been developed (such as PETG) for 3D Printing. PETG is PET copolyester with glycol modification. PETG filament is more heat-resistant and tough than PLA, but easier to print than ABS. It offers higher strength, lower shrinkage, and a smoother finish.

- Towards 3D printing recommended hot end temperature is 240 and 260°C
- Further, bed temperature is to be maintained at about 100°C
- And the retraction speed needs to be slow at 30mm/s or less

#### **(h) Toxicity and recycling of PET**

Polyethylene Terephthalate or PET products are 100% recyclable and is the most recycled plastic worldwide. PET can be easily identified by its recycling code #1. Low diffusion coefficient makes PET much more suitable than other plastic materials for use as a recovered, recycled material. Post-consumer PET bottles are collected and processed through a series of special washing processes or by a chemical treatment to break down the PET into its raw materials or intermediates which are further used to produce recycled PET (rPET) flakes.

Thereafter, the recycled PET or rPET flakes are used in several applications some of which include:

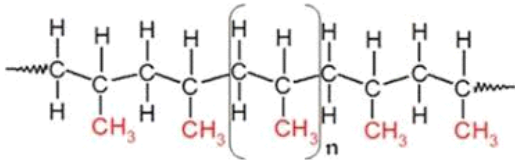
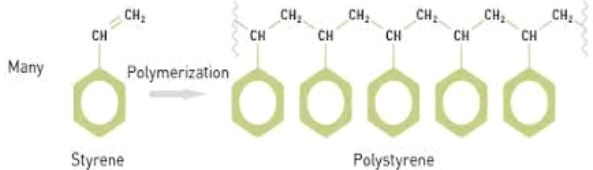
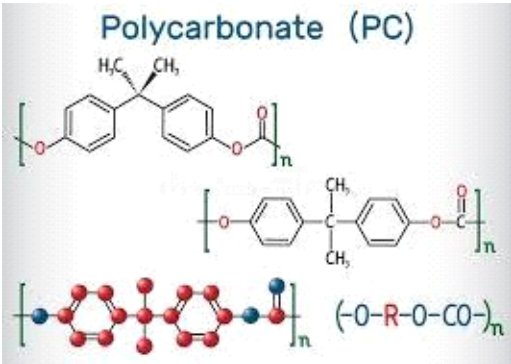

- Fiber for carpet, fleece jackets, comforter fill, and tote bags
- Containers for food, beverages(bottles), and non-food items
- Film and sheet
- Strapping

Further heat treatment of recycled PET flakes removes any volatiles making them safe and meet the requirements to be safe for direct food contact. According to ILIS study, "PET itself is biologically inert if

ingested, is dermally safe during handling and is not a hazard if inhaled. No evidence of toxicity has been detected in feeding studies using animals. Negative results from Ames tests and studies into unscheduled DNA synthesis indicate that PET is not genotoxic. Similar studies conducted with monomers and typical PET intermediates also indicate that these materials are essentially non-toxic and pose no threats to human health.”

### (i) Molecular Structure of some other polymers

A few additional examples regarding molecular structure of some other polymers is presented in Figure 1.4.

	
<p>Polypropylene</p>	<p>Polystyrene</p>
	
<p>Polycarbonate</p>	<p>Nylon</p>

**Figure 1.4: Molecular structures of Polypropylene, Polystyrene, Polycarbonate and Nylon as a reflection of the structural aspects and chain development features**

## **2. Categorisation as Common and Specialised Plastic**

The process of categorisation of plastics also includes considerations as common plastics and specialised plastics (and / or high performance plastics) which are also listed and their properties and uses indicated below (<https://en.wikipedia.org/wiki/Plastic> accessed 28 February 2020).

### **(i) Common plastics**

This category includes both commodity plastics, or standard plastics, and engineering plastics.

- Polyamides (PA) or (nylons) – fibers, toothbrush bristles, tubing, fishing line and low-strength machine parts such as engine parts or gun frames
- Polycarbonate (PC) – compact discs, eyeglasses, riot shields, security windows, traffic lights and lenses
- Polyester (PES) – fibers and textiles
- Polyethylene (PE) – a wide range of inexpensive uses including supermarket bags and plastic bottles
- High-density polyethylene (HDPE) – detergent bottles, milk jugs and molded plastic cases
- Low-density polyethylene (LDPE) – outdoor furniture, siding, floor tiles, shower curtains and clamshell packaging
- Polyethylene terephthalate (PET) – carbonated drinks bottles, peanut butter jars, plastic film and microwavable packaging
- Polypropylene (PP) – bottle caps, drinking straws, yogurt containers, appliances, car fenders (bumpers) and plastic pressure pipe systems
- Polystyrene (PS) – foam peanuts, food containers, plastic tableware, disposable cups, plates, cutlery, compact-disc (CD) and cassette boxes
- High impact polystyrene (HIPS) – refrigerator liners, food packaging and vending cups

- Polyurethanes (PU) – cushioning foams, thermal insulation foams, surface coatings and printing rollers: currently the sixth or seventh most commonly- used plastic, for instance the most commonly used plastic in cars
- Polyvinyl chloride (PVC) – plumbing pipes and guttering, electrical wire/cable insulation, shower curtains, window frames and flooring
- Polyvinylidene chloride (PVDC) – food packaging, such as: Saran
- Acrylonitrile butadiene styrene (ABS) – electronic equipment cases (e.g. computer monitors, printers, keyboards) and drainage pipe
- Polycarbonate+Acrylonitrile Butadiene Styrene (PC+ABS) – a blend of PC and ABS that creates a stronger plastic used in car interior and exterior parts, and mobile phone bodies
- Polyethylene+Acrylonitrile Butadiene Styrene (PE+ABS) – a slippery blend of PE and ABS used in low-duty dry bearings Further, the list of synthetic polymers include the following:

Table 2.1 : A list Of key Synthetic Polymers and their properties and Uses

Polymer	Abbreviation	Properties	Uses
<b>Low-density polyethylene</b>	LDPE	Chemically inert, flexible, insulator	Squeeze bottles, toys, flexible pipes, insulation cover (electric wires), six pack rings, etc.
<b>High-density polyethylene</b>	HDPE	Inert, thermally stable, tough and high tensile strength	Bottles, pipes, inner insulation (dielectric) of coax cable (see also PTFE), plastic bags, etc.
<b>Polypropylene</b>	PP	Resistant to acids and alkalies, High tensile strength	Auto parts, industrial fibers, food containers, liner in bags, dishware and as a wrapping material for textiles and food



Polymer	Abbreviation	Properties	Uses
<b>Polystyrene (thermocol)</b>	PS	Thermal insulator. Properties depends on the form, expanded form is tough and rigid	Petri dishes, CD case, plastic cutlery
<b>Polytetrafluoroethylene</b>	PTFE	Very low coefficient of friction, excellent dielectric properties, chemically inert	Low friction bearings, non-stick pans, inner insulation (dielectric) of coax cable (see also HDPE), coating against chemical attack etc.
<b>Polyvinyl chloride</b>	PVC	Insulator, flame retardant, chemically inert	Pipe (mainly draining), fencing, lawn chairs, hand-bags, curtain clothes, non-food bottles, raincoats, toys, vinyl flooring, electrical installation insulations, etc.
<b>Polychlorotrifluoroethylene</b>	PCTFE	Stable to heat and thermal attacks, high tensile strength and non wetting	valves, seals, gaskets etc.

**(ii) High-performance plastics** (<https://en.wikipedia.org/wiki/Plastic> accessed 28 Feb 2020); ([https://en.wikipedia.org/wiki/List\\_of\\_synthetic\\_polymers](https://en.wikipedia.org/wiki/List_of_synthetic_polymers) accessed 26 Feb 2020)

- Polyepoxide (epoxy) – used as an adhesive, potting agent for electrical components, and matrix for composite materials with hardeners including amine, amide, and boron trifluoride
- Polymethyl methacrylate (PMMA) (acrylic) – contact lenses (of the original "hard" variety), glazing (best known in this form by its various trade names around the world; e.g. Perspex, Plexiglas, Oroglas), aglets, fluorescent light diffusers, rear light covers for vehicles. It forms the basis of artistic and commercial acrylic paints when suspended in water with the use of other agents.
- Polytetrafluoroethylene (PTFE), or Teflon – heat-resistant, low-friction coatings, used in things like non-stick surfaces for frying pans, plumber's tape and water slides
- Phenolics or phenol formaldehyde (PF) – high modulus, relatively heat resistant, and excellent fire resistant polymer. Used for insulating parts in electrical fixtures, paper laminated products (e.g. Formica), thermally insulation foams. It is a thermosetting plastic, with the familiar trade name Bakelite, that can be molded by heat and pressure when mixed with a filler- like wood flour or can be cast in its unfilled liquid form or cast as foam (e.g. Oasis). Problems include the probability of moldings naturally being dark colors (red, green, brown), and as thermoset it is difficult to recycle.
- Melamine formaldehyde (MF) – one of the aminoplasts, used as a multi- colorable alternative to phenolics, for instance in moldings (e.g. break- resistance alternatives to ceramic cups, plates and bowls for children) and the decorated top surface layer of the paper laminates (e.g. Formica)
- Urea-formaldehyde (UF) – one of the aminoplasts, used as a multi-colorable alternative to phenolics: used as a wood adhesive (for plywood, chipboard, hardboard) and electrical switch housings.
- Polyetheretherketone (PEEK) – strong, chemical- and heat-resistant thermoplastic, biocompatibility allows for use in medical implant applications, aerospace moldings. One of the most expensive commercial polymers.
- Maleimide/bismaleimide – used in high temperature composite materials
- Polyetherimide (PEI) (Ultem) – a high temperature, chemically stable polymer that does not crystallize

- Polyimide – a high temperature plastic used in materials such as Kapton tape
- Plastarch material – biodegradable and heat-resistant thermoplastic composed of modified corn starch
- Polylactic acid (PLA) – a biodegradable, thermoplastic found converted into a variety of aliphatic polyesters derived from lactic acid, which in turn can be made by fermentation of various agricultural products such as cornstarch, once made from dairy products
- Furan – resin based on furfuryl alcohol used in foundry sands and biologically derived composites
- Silicone poly (diketoenamine heat resistant resin used mainly as a sealant but also used for high temperature cooking utensils and as a base resin for industrial paints
- Polysulfone – high temperature melt processable resin used in membranes, filtration media, water heater dip tubes and other high temperature applications
- Polydiketoenamine (PDK) – a new type of plastic that can be dunked in acid and reshaped endlessly, currently being lab tested.[18]

## **2.1 Additives and fillers in plastics and the issue of Toxicity**

The manufacture of plastics involves not only monomers and polymers and their processing via different types of reactions and development of polymer chains to display various properties for varied applications, but also incorporation of a variety of additives and fillers that play a key role in developing and imparting the desired properties as well. An insight on these is reflected below.

### **Additives and their variety**

It is indicative that blended into most plastics are additional organic or inorganic compounds that are additives which further contribute to the characteristics. It is also important to note that many of the controversies associated with plastics actually relate to the additives and some like organotin compounds are particularly toxic (Hans-Georg Elias, 2005; Teuten EL, Saquing JM, Knappe DR, et al. July 2009).

Typical additives include:

### (a) Stabilizers

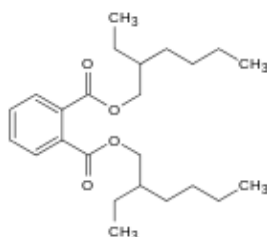
The Polymer stabilizers prolong the lifetime of the polymer by suppressing degradation that results from UV-light, oxidation, and other phenomena. Typical stabilizers thus absorb UV light or function as antioxidants.

### (b) Fillers

Many plastics contain fillers, to improve performance or reduce production costs (Kulshreshtha, A. K.; Vasile, Cornelia (2002). It is indicated that typically fillers are mineral in origin, e.g., chalk. Other fillers include: starch, cellulose, wood flour, ivory dust and zinc oxide. Some of the features of fillers are that :-

- Most fillers are relatively inert and inexpensive materials, make the product cheaper by weight.
- stabilizing additives include fire retardants, to lower the flammability of the material.
- Some fillers are more chemically active and are called: reinforcing agents (Ref. Seymour et al., 1987)

### (c) Plasticizers



Plasticizers are, by mass, often the most abundant additives (Teuten EL et al., 2009). These oily but nonvolatile compounds are blended in to plastics to improve rheology, as many organic polymers are otherwise too rigid for particular applications. One of the common plasticisers is Dioctyl Thalate. .

### (d) Colorants

It is commonly noted that plastics and plastic products and components are colourful which is enabled by Colorants that are another common additive, though their weight contribution is small.

A list of common additives is presented in **Table 2.2** along with information on key properties.

Table 2.2: Additives in five common polymers indicating their function and relative proportion

Polymer (sustances)	Additive Type	Quantity in Polymer	Hazardous (%w/w)
<b>PP</b>	Antioxidant	0.05-3	Bisphenol A, octylphenol, Nonylphenol
	Flame retardant (cable insulation and electronic applications)	12-18	Brominated flame retardant, Boric acid, Tris(2-chloroethyl) phosphate
<b>HDPE</b>	Antioxidants	0.05-3	Bisphenol A, Octylphenol, Nonylphenol
	Flame retardant (cable insulation application)	12-18	Brominated flame retardant, Boric acid, Tris(2-chloroethyl) phosphate
<b>LDPE</b>	Antioxidants	0.05-3	Bisphenol A, Octylphenol, Nonylphenol
	Flame retardant (cable insulation application)	12-18	Brominated flame retardant, Boric acid, Tris(2-chloroethyl) phosphate
<b>PVC</b>	Plasticizer	10-70	Phthalate
	Stabilizer	0.5-3	Bisphenol A, Nonylphenol
<b>PUR</b>	Flame retardant	12-18	Brominated flame retardant, Boric acid, Tris(2-chloroethyl) phosphate

## 2.2 The problem of Toxicity

While pure plastics have low toxicity due to their insolubility in water and because they are biochemically inert, due to a large molecular weight, the plastic products contain a variety of additives, some of which can be toxic ( Hahladakis, John N. et al, 2018). As an example, it is observed that plasticizers like adipates and phthalates are often added to brittle plastics like polyvinyl chloride to make them pliable enough for use in food packaging, toys, and many other items. However, traces of these compounds can leach out of the product. Owing to concerns over the effects of such leachates, the European Union has restricted the use of DEHP (di-2-ethylhexyl phthalate) and other phthalates in some applications, and the United States has limited the use of DEHP, DPB, BBP, DINP, DIDP, and DnOP in children's toys and child care articles with the Consumer Product Safety Improvement Act. Further, some compounds leaching from polystyrene food containers have been sought to be assessed with the proposition that they interfere with hormone functions and are suspected human carcinogens (Ref. *McRandle, P.W., 2004*). Other chemicals of potential concern include alkylphenols (Teuten EL,et al., 2009).

In other circumstances and cases while the finished plastic may be non-toxic, the monomers used in the manufacture of the parent polymers may be toxic. In some cases, small amounts of those chemicals can remain trapped in the product unless suitable processing is employed. For example, the World Health Organization's International Agency for Research on Cancer (IARC) has recognized vinyl chloride, the precursor to PVC, as a human carcinogen (McRandle, P.W., 2004).

### **The case of Bisphenol A.**

Some polymers may also decompose into the monomers or other toxic substances when heated. In 2011, it was reported that "almost all plastic products" sampled released chemicals with estrogenic activity, although the researchers identified plastics which did not leach chemicals with estrogenic activity (Ref. Yang, Chun Z. et al., 2011). It is indicative that the primary building block of polycarbonates, bisphenol A (BPA), is an estrogen-like endocrine disruptor that may leach into food. The research in Environmental Health Perspectives finds that BPA

leached from the lining of tin cans, dental sealants and polycarbonate bottles can increase body weight of lab animals' offspring. A more recent animal study suggests that even low-level exposure to BPA results in insulin resistance, which can lead to inflammation and heart disease (McRandle, P.W., 2004; Rubin, BS et al. 2001; Alonso-Magdalena, et al., 2006). Further, Bis(2-ethylhexyl) adipate, present in plastic wrap based on PVC, is also of concern, as are the volatile organic compounds present in new car smell. The European Union has a permanent ban on the use of phthalates in toys. In 2009, the United States government banned certain types of phthalates commonly used in plastic (Lisa Wade McCormick, 2009).

### 3. The properties and processing / production / fabrication and technology aspects with Plastics – An overview

The distinction between carbon-chain and heterochain polymers is reflected in the table 2.7, in which selected properties and applications of the most important carbon-chain and heterochain plastics are shown. It is important to note that for each polymer type listed in the table there can be many subtypes, since any of a dozen industrial producers of any polymer can offer 20 or 30 different variations for use in specific applications. For this reason the properties indicated in the table must be taken as approximations.

The stress and strain graph and diagram of different polymer types and reflection of Hookean and Non Hookean curves is presented in **Figure 3.1**.

The properties enable identification of appropriate polymer types and their use in various product streams as per product design requirements.

Table 3.1: Key physico – chemical properties of plastics

<b>Properties and applications of commercially important plastics</b>						
<b>Polyme r type</b>	<b>family</b>	<b>and</b>	<b>Densit y (g/cm 3)</b>	<b>Degree of crystallinity</b>	<b>Glass transition temperatur e (°c)</b>	<b>Crystal meting temperatur e (°C)</b>
Thermoplastics						

<b>Properties and applications of commercially important plastics</b>						
<b>Polyme r type</b>	<b>family</b>	<b>and</b>	<b>Densit y (g/cm 3)</b>	<b>Degree of crystallinity</b>	<b>Glass transition temperatur e (°c)</b>	<b>Crystal meting temperatur e (°C)</b>
<b>Carbon-chain</b>						
High-density polyhtene (HDPE)			0.95-0.97	High	-120	137
Low-density polythene (LDPE)			0.92-0.93	Moderate	-120	110
Polypropylene (PP)			0.90-0.91	High	-20	176
Polystyrene (PS)			1.0-1.1	nil	100	-
Acrylonitrile-butadiene-styrene (ABS)			1.0-1.1	nil	90-120	-
Polyvinyl chloride unplasticized (PVC)			1.3-1.6	nil	85	-
Polymethyl methacrylate (PMMA)			1.2	nil	115	-
Polytetrafluoroethylene (PTFE)			2.1-2.2	moderate- high	126	327
<b>Hetero chain</b>						
Polyehthylene terephthalate (PET)			1.3-1.4	Moderate	69	265
Polycarbonate (PC)			1.2	Low	145	230
Polyacetal			1.4	Moderate	-50	180
Polyetheretherketone (PEEK)			1.3	Nil	185	-
Polyphenylene sulphide (PPS)			1.35	Moderate	88	288
Cellulose diacetate			1.3	Low	120	230
Polycaprolactam (nylon 6)			1.1-1.2	moderate	50	210-220
<b>Thermosets*</b>						
<b>Heterochain</b>						
Polyester (unsaturated)			1.3-2.3	nil	-	-
Epoxies			1.1-1.4	nil	-	-



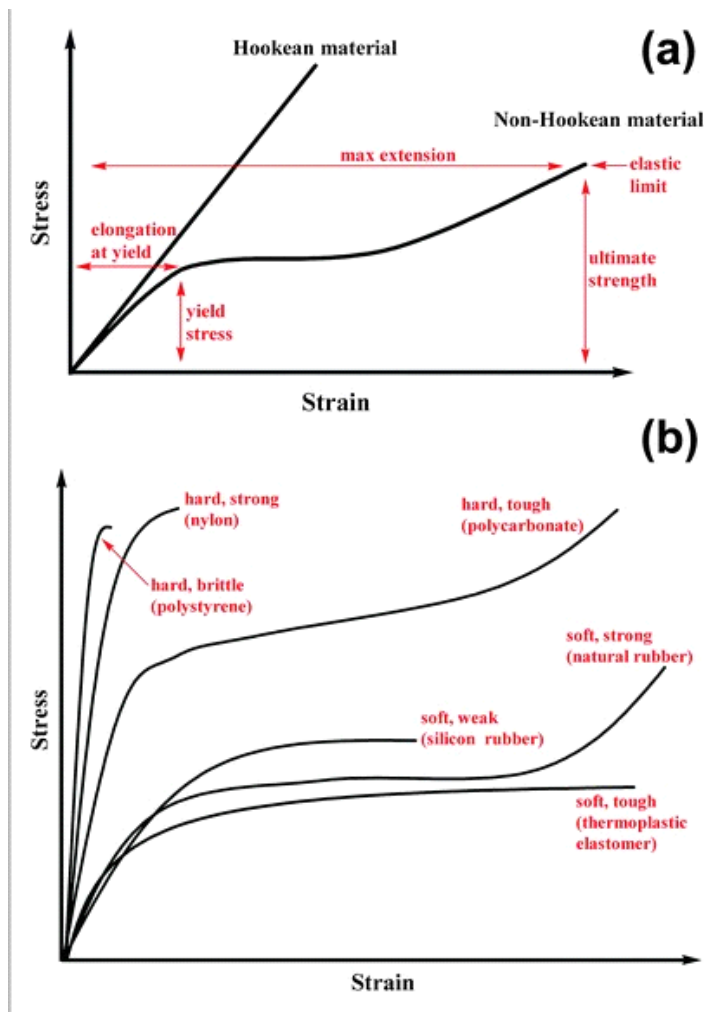
<b>Properties and applications of commercially important plastics</b>						
<b>Polymer type</b>	<b>family</b>	<b>and</b>	<b>Density (g/cm<sup>3</sup>)</b>	<b>Degree of crystallinity</b>	<b>Glass transition temperature (°C)</b>	<b>Crystallization temperature (°C)</b>
Phenol formaldehyde			1.7-2.0	nil	-	-
Urea and melamine formaldehyde			1.5-2.0	nil	-	-
Polyurethane			1.05	low	-	-

Additional features and physical and strength parameters such as tensile strength, elongation at break and flexural modulus for different types of plastics is presented in Table 3.2.

**Table 3.2: Tensile strength and flexural modulus of some polymers and polymer family and types**

<b>Polymer Family and Type</b>	<b>Tensile Strength (Mpa)</b>	<b>Elongation at Break (%)</b>	<b>Flexural Modulus (Gpa)</b>
<b>Thermoplastics</b>			
<b>Carbon-chain</b>			
High-density polyethylene (HDPE)	20-30	10-1,000	1-1.5
Low-density polyethylene (LDPE)	8-30	100-650	0.25-0.35
Polypropylene (PP)	30-40	100-600	1.2-1.7
Polystyrene (PS)	35-50	1-2	2.6-3.4
Acrylonitrile-butadiene-styrene (ABS)	15-55	30-100	0.9-3.0
Polyvinyl chloride unplasticized (PVC)	40-50	2-80	2.1-3.4
Polymethyl methacrylate (PMMA)	50-75	2-10	2.2-3.2
Polytetrafluoroethylene (PTFE)	20-35	200-400	0.5
<b>Heterochain</b>			
Polyethylene terephthalate (PET)	50-75	50-300	2.4-3.1
Polycarbonate (PC)	65-75	110-120	2.3-2.4

<b>Polymer Family and Type</b>	<b>Tensile Strength (Mpa)</b>	<b>Elongation at Break (%)</b>	<b>Flexural Modules (Gpa)</b>
Polyacetal	70	25-75	2.6-.3.4
Polyetheretherketone (PEEK)	70-105	30-150	3.9
Polyphenylene sulphide (PPS)	50-90	1-10	3.8-4.5
Cellulose diacetate	15-65	6-70	1.5
Polycaprolactam (nylon 6)	40-170	30-300	1.0-2.8
<b>Thermosets*</b>			
<b>Heterochain</b>			
Polyester (unsaturated)	20-70	<3	7-14
Epoxies	35-140	<4	14-30
Phenol formaldehyde	50-125	<1	8-23
Urea and melamine formaldehyde	35-75	<1	7.5
Polyurethane	70	3-6	4



**Figure 3.1: The stress and strain graph and diagram of different polymer types and reflection of Hookean and Non Hookean curves**

### 3.1 The processing / production / fabrication and technology aspects with Plastics – An outline

The processing of raw materials into usable forms is termed fabrication or conversion. An example from the plastics industry would be the conversion of plastic pellets into films or the conversion of films into food containers. The processes that get involved include mixing, forming, finishing, and fibre reinforcing of plastics etc (<https://www.britannica.com/science/plastic/Foaming> accessed 17 March 2020)

#### (i) Compounding

The first step in most plastic fabrication procedures is compounding, the mixing together of various raw materials in proportions according to a specific recipe. Most often the plastic resins are supplied to the fabricator as cylindrical pellets (several milli-metres in diameter and length) or as flakes and powders. Other forms include viscous liquids, solutions, and suspensions. It is to be noted that the chemical processes of formation of polymer chains and the solutions conversion into pellets as part of the chemical engineering features precedes the mechanical stage of processing /production / fabrication.

It is indicated that mixing liquids with other ingredients may be done in conventional stirred tanks, but certain operations demand special machinery. Dry blending refers to the mixing of dry ingredients prior to further use, as in mixtures of pigments, stabilizers, or reinforcements. However, polyvinyl chloride (PVC) as a porous powder can be combined with a liquid plasticizer in an agitated trough called a ribbon blender or in a tumbling container. This process also is called dry blending, because the liquid penetrates the pores of the resin, and the final mixture, containing as much as 50 percent plasticizer, is still a free-flowing powder that appears to be dry.

At this stage of mixing operations a key mixer or the workhorse mixer of the plastics and rubber industries is the internal mixer, in which heat and pressure are applied simultaneously. One of the mixer designs is the Banbury mixer (Figure 3.3) which resembles a robust dough mixer in that two interrupted spiral rotors move in opposite directions at 30 to 40 rotations per minute. Here the shearing action is intense, and the power input can be as high as 1,200 kilowatts for a 250-kg (550-pound) batch of molten resin with finely divided pigment.



**Figure 3.3 : The Banbury mixer, used for the mixing of polymers and additives in the manufacture of plastic and rubber. *Courtesy of Farrel Corporation***

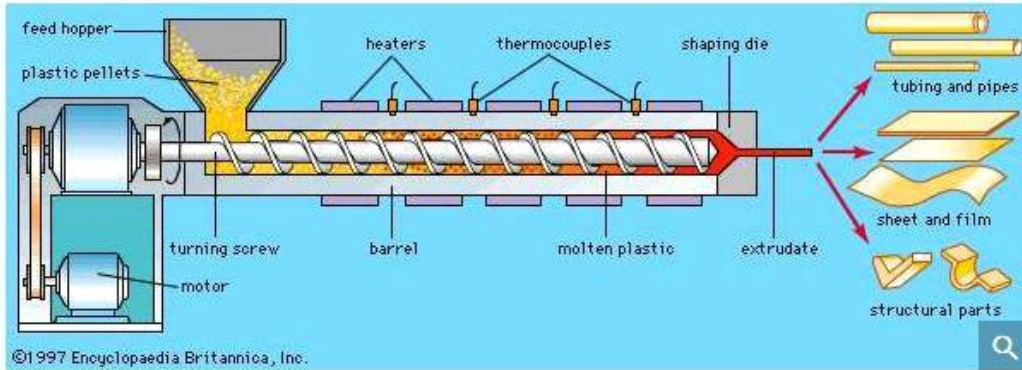
In some cases, mixing may be integrated with the extrusion or molding step, as in twin-screw extruders.

**(ii) Forming**

The process of forming plastics into various shapes typically involves the steps of melting, shaping, and solidifying. As an example, polyethylene pellets can be heated above  $T_m$ , placed in a mold under pressure, and cooled to below  $T_m$  in order to make the final product dimensionally stable. Thermoplastics in general are solidified by cooling below  $T_g$  or  $T_m$ . Thermosets are solidified by heating in order to carry out the chemical reactions necessary for network formation.

**(iii) Extrusion**

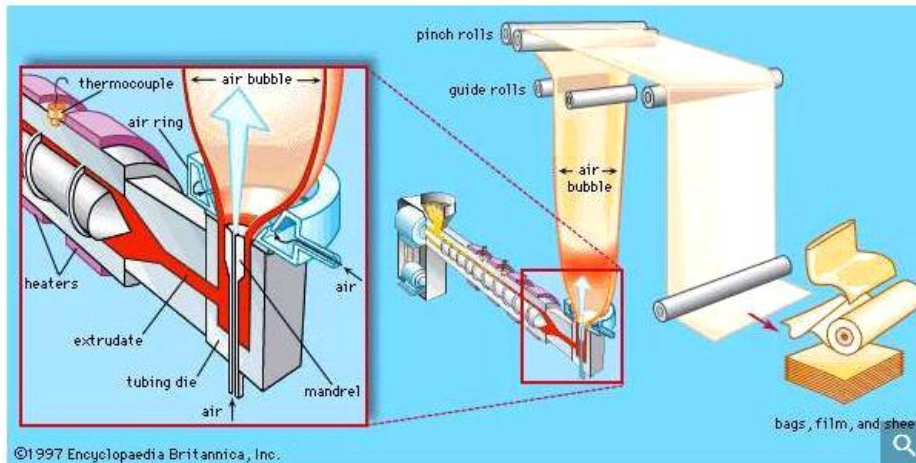
In the process of extrusion, a melted polymer is forced through an orifice with a particular cross section (the die), and a continuous shape is formed with a constant cross section similar to that of the orifice. It may be noted that although thermosets can be extruded and cross-linked by heating the extrudate, thermoplastics that are extruded and solidified by cooling are much more common. Among the products that can be produced by extrusion are film, sheet, tubing, pipes, insulation, and home siding. In each case the profile is determined by the die geometry, and solidification is by cooling. Figure- 3.4 presents a longitudinal section of a screw extruder of thermoplastic polymers. Here plastic pellets are fed from a hopper into the barrel of the extruder, where the pellets are gradually melted by mechanical energy generated by a turning screw and by heaters arranged along the barrel. The molten polymer is forced through a die, which shapes the extrudate into products



**Figure 3.4: Longitudinal section of a screw extruder of thermoplastic polymers**

(Source *Encyclopedia Britannica, Inc.*)

It is further to be noted that most plastic grocery bags and similar items are made by the continuous extrusion of tubing. Here in blow extrusion, the tube is expanded before being cooled by being made to flow around a massive air bubble. Air is prevented from escaping from the bubble by collapsing the film on the other side of the bubble. For some applications, laminated structures may be made by extruding more than one material at the same time through the same die or through multiple dies. Multilayer films are useful since the outer layers may contribute strength and moisture resistance while an inner layer may control oxygen permeability—an important factor in food packaging. The layered films may be formed through blow extrusion, or extrudates from three machines may be pressed together in a die block to form a three-layer flat sheet that is subsequently cooled by contact with a chilled roll. Figure 3.5 presents the features of blow extrusion of thermoplastic polymers. Here molten extrudate is forced past a tubing mandrel, expanded into a balloon shape by a stream of air, drawn upward by rollers, and pinched into a collapsed sheet to be cut into a number of products.



**Figure 3.5: Blow extrusion of thermoplastic polymers (Encyclopædia Britannica, Inc.)**

It is to be noted that the flow through a die in extrusion always results in some orientation of the polymer molecules. Orientation may be increased by drawing—that is, pulling on the extrudate in the direction of polymer flow or in some other direction either before or after partial solidification. In the blow extrusion process, polymer molecules are oriented around the circumference of the bag as well as along its length, resulting in a biaxially oriented structure that often has superior mechanical properties over the unoriented material.

#### **(iv) Compression Molding**

In the simplest form of compression molding, a molding powder (or pellets, which are also sometimes called molding powder) is heated and at the same time compressed into a specific shape. In the case of a thermoset, the melting must be rapid, since a network starts to form immediately, and it is essential for the melt to fill the mold completely before solidification progresses to the point where flow stops. The highly cross-linked molded article can be removed without cooling the mold. Adding the next charge to the mold is facilitated by compressing the exact required amount of cold molding powder into a preformed “biscuit.” Also, the biscuit can be preheated by microwave energy to near the reaction temperature before it is placed in the mold cavity. A typical heater, superficially resembling a microwave oven, may apply as much as 10 kilovolts at a frequency of one megahertz. Commercial molding machines use high pressures and temperatures to shorten the

cycle time for each molding. The molded article is pushed out of the cavity by the action of ejector pins, which operate automatically when the mold is opened. In some cases, pushing the resin into the mold before it has liquefied may cause undue stresses on other parts. For example, metal inserts to be molded into a plastic electrical connector may be bent out of position. This problem is solved by transfer molding, in which the resin is liquefied in one chamber and then transferred to the mold cavity.

In one form of compression molding, a layer of reinforcing material may be laid down before the resin is introduced. The heat and pressure not only form the mass into the desired shape but also combine the reinforcement and resin into an intimately bound form. When flat plates are used as the mold, sheets of various materials can be molded together to form a laminated sheet. Ordinary plywood is an example of a thermoset-bound laminate. In plywood, layers of wood are both adhered to one another and impregnated by a thermoset such as urea-formaldehyde, which forms a network on heating.

#### **(v) Injection molding**

It is usually slow and inefficient to mold thermoplastics using the compression molding techniques described above. In particular, it is necessary to cool a thermoplastic part before removing it from the mold, and this requires that the mass of metal making up the mold also be cooled and then reheated for each part. Injection molding is a method of overcoming this inefficiency. Injection molding resembles transfer molding in that the liquefying of the resin and the regulating of its flow is carried out in a part of the apparatus that remains hot, while the shaping and cooling is carried out in a part that remains cool. In a reciprocating screw injection molding machine, material flows under gravity from the hopper onto a turning screw. The mechanical energy supplied by the screw, together with auxiliary heaters, converts the resin into a molten state. At the same time the screw retracts toward the hopper end. When a sufficient amount of resin is melted, the screw moves forward, acting as a ram and forcing the polymer melt through a gate into the cooled mold. Once the plastic has solidified in the mold, the mold is unclamped and opened, and the part is pushed from the mold by automatic ejector pins. The mold is then closed and clamped, and the screw turns and retracts again to repeat the cycle of liquefying a



new increment of resin. For small parts, cycles can be as rapid as several injections per minute. Figure 3.6 presents schematic / section of the injection molding process. In this figure in the first unit from the left plastic pellets are fed from a hopper into a reciprocating screw injection molding machine, where they are melted by the mechanical energy exerted by a turning screw and by heaters arranged along the barrel. In the middle and second unit is reflected aspects of the screw moving forward, injecting the molten plastic into a mold. In the rightmost section / unit it is a situation that after the plastic has solidified, the mold is opened and the molded piece ejected.

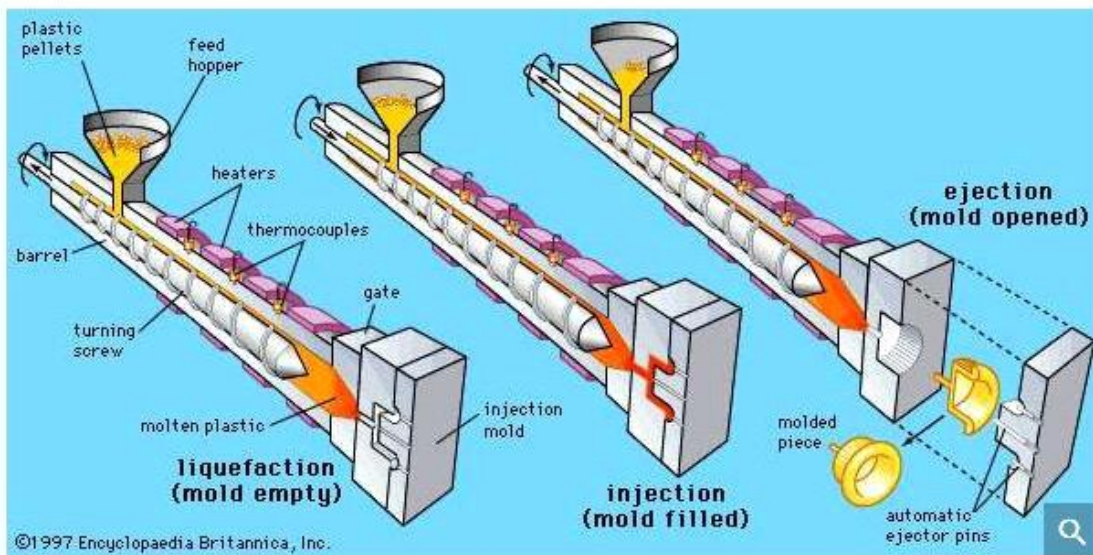


Figure 3.6: Injection molding of thermoplastic polymers (Encyclopædia Britannica, Inc.)

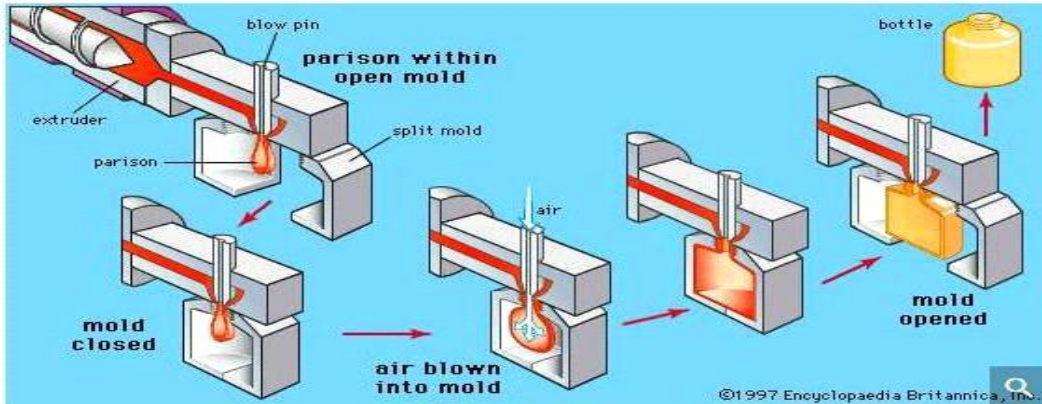
#### (vi) Reaction injection molding

One type of network-forming thermoset, polyurethane, is molded into parts such as automobile bumpers and inside panels through a process known as reaction injection molding, or RIM. The two liquid precursors of a polyurethane are a multifunctional isocyanate and a prepolymer, a low-molecular-weight polyether or polyester bearing a multiplicity of reactive end-groups such as hydroxyl, amine, or amide. In the presence of a catalyst such as a tin soap, the two reactants rapidly form a network joined mainly by urethane groups. The reaction takes place so rapidly that the two precursors have to be combined in a special mixing head and immediately introduced into

the mold. However, once in the mold, the product requires very little pressure to fill and conform to the mold—especially since a small amount of gas is evolved in the injection process, expanding the polymer volume and reducing resistance to flow. The low molding pressures allow relatively lightweight and inexpensive molds to be used, even when large items such as bumper assemblies or refrigerator doors are formed.

### **(vii) Blow molding**

The popularity of thermoplastic containers for products previously marketed in glass is especially due to the development of blow molding. In this technique, a thermoplastic hollow tube, the parison, is formed by injection molding or extrusion. In heated form, the tube is sealed at one end and then blown up like a balloon. The expansion is carried out in a split mold with a cold surface; as the thermoplastic encounters the surface, it cools and becomes dimensionally stable. The parison itself can be programmed as it is formed with varying wall thickness along its length, so that, when it is expanded in the mold, the final wall thickness will be controlled at corners and other critical locations. In the process of expansion both in diameter and length (stretch blow molding), the polymer is biaxially oriented, resulting in enhanced strength and, in the case of polyethylene terephthalate (PET) particularly, enhanced crystallinity. Figure 3.7 presents the features and sectional view of blow molding process. Here visualizing in a counterclockwise manner from top we see a molten polymer being extruded into a hollow tube-shaped parison. A split mold is closed around the parison, which is expanded against the sides of the mold by a stream of air. Once the plastic has solidified, the mold is opened and the shaped bottle released.



**Figure 3.7: Blow molding of plastic containers (Encyclopædia Britannica, Inc.)**

It is to be noted that blow molding has been employed to produce bottles of polyethylene, polypropylene, polystyrene, polycarbonate, PVC, and PET for domestic consumer products. It also has been used to produce fuel tanks for automobiles. In the case of a high-density-polyethylene tank, the blown article may be further treated with sulfur trioxide in order to improve the resistance to swelling or permeation by gasoline.

### **(viii) Casting and dipping**

It is further to be emphasized that not every forming process requires high pressures. If the material to be molded is already a stable liquid, simply pouring (casting) the liquid into a mold may suffice. Since the mold need not be massive, even the cyclical heating and cooling for a thermoplastic is efficiently done. One example of a cast thermoplastic is a suspension of finely divided, low-porosity PVC particles in a plasticizer such as dioctyl phthalate (DOP). This suspension forms a free-flowing liquid (a plastisol) that is stable for months. However, if the suspension (for instance, 60 parts PVC and 40 parts plasticizer) is heated to 180 °C (356 °F) for five minutes, the PVC and plasticizer will form a homogeneous gel that will not separate into its components when cooled back to room temperature. A very realistic insect or fishing worm can be cast from a plastisol using inexpensive molds and a cycle requiring only minutes. In addition, when a mold in the shape of a hand is dipped into a plastisol and then removed, subsequent heating will produce a glove that can be stripped from the mold after cooling. Further, in this case and process

Thermoset materials can also be cast. For example, a mixture of polymer and multifunctional monomers with initiators can be poured into a heated mold. When polymerization is complete, the article can be removed from the mold. A transparent lens can be formed in this way using a diallyl diglycol carbonate monomer and a free-radical initiator.

#### **(ix) Rotational molding**

It is further highlighted that in order to make a hollow article, a split mold can be partially filled with a plastisol or a finely divided polymer powder. Further, rotation of the mold while heating converts the liquid or fuses the powder into a continuous film on the interior surface of the mold. When the mold is cooled and opened, the hollow part can be removed. Among the articles produced in this manner are many toys such as balls and dolls.

#### **(x) Thermoforming and cold molding**

Another approach to plastics products formation is thermoforming and cold molding. When a sheet of thermoplastic is heated above its  $T_g$  or  $T_m$ , it may be capable of forming a free, flexible membrane as long as the molecular weight is high enough to support the stretching. In this heated state, the sheet can be pulled by vacuum into contact with the cold surface of a mold, where it cools to below  $T_g$  or  $T_m$  and becomes dimensionally stable in the shape of the mold. Cups for cold drinks are formed in this way from polystyrene or PET. Vacuum forming is only one variation of sheet thermoforming. The blow molding of bottles described above differs from thermoforming only in that a tube rather than a sheet is the starting form. Even without heating, some thermoplastics can be formed into new shapes by the application of sufficient pressure. This technique, called cold molding, has been used to make margarine cups and other refrigerated food containers from sheets of acrylonitrile-butadiene-styrene copolymer.

The above range of techniques and methods is one set of approaches to making plastics material based products, be it for thermoplastic material or thermosetting material use. There are more techniques and approaches to develop various types of plastics based

and composite material based products of varying sizes and shapes, including a vast variety of parts for integrating to other range of materials usage in the finished products making, and a classic example is the vast range of electrical and electronic goods containing plastics based material / components usage as well along with wide range of metals and other materials usage.

### **A comparison on Energy Benchmarks in production of plastic**

It has been estimated in USA that the production of plastics from crude oil requires 62 to 108 MJ/Kg of specific energy consumption (taking into account the average efficiency of US utility stations of 35%). In a comparative context producing silicon and manufacturing semiconductors for modern electronic equipment is even more energy consuming to the extent of 230 to 235 MJ/Kg of silicon, and about 3,000 MJ/Kg of semiconductors ( weblink "The monster footprint of digital technology". Low-Tech Magazine). And it is also indicative that this is also higher than the energy needed to produce many other materials, including iron (from iron ore) which requires 20-25 MJ/Kg of energy, glass (from sand, etc.) requiring 18–35 MJ/Kg, steel (from iron) needing 20–50 MJ/Kg, besides paper (from timber) produced with an input of 25–50 MJ/Kg ( Weblink : "How much energy does it take (on average) to produce 1 kilogram of the following materials?". Low-Tech Magazine).

## **4 Plastics Composition, Application & Impacts**

In the current context of consumption, the most important polymers and their applications are listed in **Table 1**. It also describes synthetic fibres derived from polyster (PES) and PET, polyacrylonitrile (acrylic, PAN), polyamide (nylon, PA), polypropylene (PP) and polyether-polyurea co-polymer (Spandex) which are used in manufacturing textiles and rope. Synthetic fibres are majorly used for manufacturing fabrics using combinations of synthetic polymers and natural fibres. Natural and synthetic fibres occur in two forms, Staple fibre and Filament fibres.

Table 4.1: Typical applications by polymer, excluding fibres

<b>Polymer</b>	<b>Applications</b>
Acrylonitrile butadiene styrene resin (ABS)	High impact parts in automobiles

<b>Polymer</b>	<b>Applications</b>
Polybutylene terephthalate (PBT)	Optical fibres
Polycarbonate (PC)	Substitute glass in greenhouses, roofing sheets, spectacles
Polyethylene – low and linear low density (PE-LD - PE-LLD)	Bags, trays, containers, agricultural film, food packaging film
Polyethylene – high and medium density (PE-HD / PE-MD)	Toys, milk bottles, shampoo bottles, pipes, household goods
Polyethylene terephthalate (PET)	Bottles for water and other drinks, dispensing containers for cleaning fluids, outdoor clothing, other textiles
Poly(methyl) methacrylate (PMMA)	Touch screens for electronic goods
Polypropylene (PP)	Food packaging, snack/sweet wrappers, microwave-proof containers, automotive parts, bank notes
Polystyrene (PS)	Spectacle frames, cutlery, plates and cups
Expanded polystyrene (EPS)	Packaging, insulated food packaging, building insulation, buoyancy
Polytetrafluoroethylene (PTFE)	Telecommunication cables
Polyurethane (PUR)	Building insulation, insulation for fridges/freezers, foam mattresses
Polyvinyl chloride (PVC)	Window frames, floor and wall coverings, cable insulation
Other thermoset and thermoplastics	Epoxy resins, surgical devices, seals, coatings and many other diverse uses
<b>Synthetic Fibres</b>	<b>Applications</b>
Polyacrylonitrile (PAN)	Thermal clothing, fire-resistant fabrics, carpets, protective clothing, hair extensions, faux fur
Polyamide (aliphatic) (PA)	Nylon PA6, PA 66 – clothing, other textiles, rope, fishing line
Polyamide (aromatic) (PA)	Body armour, racing sails, bicycle tyres, rope e.g. Kevlar™
Polyester (PES)	Clothing, other textiles
Polypropylene (PP)	Thermal clothing, sleeping bag filler
Polyether-polyurea (Spandex)	Sportswear, swimwear, undergarments e.g. Elastane, Lycra™

*Source: UN Environment (2018); Exploring the Potential for Adopting Alternative Materials to Reduce Marine Plastic Litter*

**Table 4.2** describes the semi-synthetic products, their source, chemical processes involved and their applications.

Table 4.2: Semi-synthetic Fibres and Films (types) Source, Chemical Process and Application

Product	Common biomass Source	Chemical process	Application
<b>Rayon</b>			
Viscose	Bamboo, cotton, hemp, wood pulp	Sodium hydroxide and hydrogen disulphide	Clothing fabrics
Lyocell (formerly Tencel®)	Oak and birch trees	Sulphurous acid or sulphate (kraft) process, followed by dissolution in N-methylmorpholine N-oxide	Clothing fabrics
Modal®	Beech wood	Sodium hydroxide and hydrogen disulphide	
(closed-loop in Lensing factory, Austria)	Clothing fabrics		
Cupro	Cotton linter	Cuproammonium (ammonia and copper oxide)	Clothing fabrics
<b>Other materials</b>			
Cellophane	Cotton, hemp, wood pulp	Sodium hydroxide and hydrogen disulphide	Packaging, food contact packaging, adhesive tape
Natureflex™ (Cellophane)	Cotton, hemp, wood pulp	Sodium hydroxide and hydrogen disulphide	Packaging, food contact packaging
Cellulose acetate	Cotton, wood pulp	Acetic acid, acetic anhydride, sulphuric acid, acetone	Photographic film, clothing fabrics, cigarette filters

Source: UN Environment (2018); Exploring the Potential for Adopting Alternative Materials to Reduce Marine Plastic Litter

A number of additives are added to the plastic polymers to improve their specific properties like resistance to fire, UV, biodegradation, heat, oxidation and acid. Common additives which are used are given below in **Table 4.3**. These additives may also cause the health impacts and hence banned from their usage. Some of these compounds include substances such as bisphenol A (BPA); brominated flame retardants; phthalates; and cadmium/barium and lead stabilizers.

Table 4.3: Additive Use in Polymers

Additive	% Weight of the Polymer Present
Stabilisers	Up to 4%
Plasticisers	Present in flexible PVC at levels of 20-60%
Mineral flame retardants	In soft PVC cables, insulation and sheathing from 5-30%
Fillers	Typically calcium carbonate is present in PVC flooring at very high proportion (50%) and in pipes from 0-30% or more. Talc and glass fibres are used in PP for automotive applications, typically in the range of 20-40%. Glass fibres are also found in engineering polymers (such as PA or PBT), for reinforcement in the range 5-70%.
Pigments	Titanium dioxide is present in window profiles at 4-8%.

Source: OECD (2018); Improving Markets for Recycled Plastics – Trends, Prospects and Policy Responses

Lithner *et al.* (2011) have summarized the hazard rankings for selected polymers (**Table 4.4**).

Table 4.4: Ranking of Selected Polymers Based on the Hazard Classification Component Monomers

Polymer	Monomer(s)	Hazard level	Hazard score
Polyurethane (PUR)	Propylene oxide, ethylene Oxide	V	13,844
Polyacrylonitrile (PAN)	Acrylamide	V	11,521
Polyvinyl chloride (PVC) – plasticized	Vinyl chloride	V	10,551
Acrylonitrile–butadiene–styrene (ABS) Terpolymer	Styrene, acrylonitrile	V	6,552
Epoxy resin DGEBA	Bisphenol A	V	4,226
Polycarbonate (PC)	Bisphenol A, phosgene	IV	1,177



Polymer	Monomer(s)	Hazard level	Hazard score
Polymethyl methacrylate (PMMA)	Methyl methacrylate	IV	1,021
Polyamide 6 (PA) (nylon 6)	$\epsilon$ -caproamide	II	50
Expanded polystyrene (EPS)	Styrene	II	44
Polystyrene (PS)	Styrene	II	30
High-density polyethylene (HDPE)	Ethylene	II	11
Low-density polyethylene (LDPE)	Ethylene	II	11
Linear-low-density polyethylene (LLDPE)	Ethylene	II	10
Polyethylene terephthalate (PET)	Dimethyl terephthalate, ethylene glycol	II	4
PP	Propylene	I	1
PVAc	Vinyl acetate	I	1

**Note:** The hazard score for some polymers will vary depending on the plasticiser used (e.g. PVC) or the incorporation of another monomer (e.g. PAN)

Some of the chemicals with endocrine disrupting (EDCs) properties are additives in plastics as described in **Table 4.5**.

Table 4.5: Examples of common plastic additives, associated functions, potential effect and status under the Stockholm Convention

Additive	Function	Effect	Listing under Stockholm Convention <sup>a</sup>
Phthalates	Plasticiser used to soften plastics, especially PVC	Endocrine disruptor	
Nonylphenol	Antioxidant and Plasticizer	Endocrine disruptor	
Bisphenol A (BPA)	Antioxidant and plasticiser (PP, PE,	Oestrogen mimic	

	PVC)		
Brominated flame retardants (BFR)	Reduce flammability	Endocrine disruptor	
Hexabromobiphenyl	Reduce flammability	Endocrine disruptor	Elimination
Hexabromocyclododecane	Reduce flammability	Endocrine disruptor	Elimination <sup>b</sup>
commercial penta, octa and decabromodiphenyl ether	Reduce flammability	Endocrine disruptor	Elimination
Short-chain chlorinated paraffins (SCCP)	Plasticiser, reduce Flammability	Carcinogenic	Elimination
Pentadecafluorooctanoic acid (PFOA)	Surfactant in production of fluropolymers and as water and stain protection on textiles	Carcinogenic	Under consideration

<sup>a</sup>as of October 2017; <sup>b</sup>special exemption for the production and use of HBCD in EPS for building

Source: UN Environment (2018); *Exploring the Potential for Adopting Alternative Materials to Reduce Marine Plastic Litter*

**Table 4.1 to Table 4.5 describe major polymers, their applications, specific composition, their hazards and EDC properties, which can impact terrestrial and aquatic environment if target groups are exposed to waste streams from riparian cities, which are mismanaged in any geographical boundary.** For example plastic emissions from uncontrolled dump sites and effluent discharge into water bodies like lakes, rivers seas and oceans. If not properly collected, plastic waste can decay and cause air pollution and degradation of soil, surface and groundwater, and aquatic and marine ecosystems.

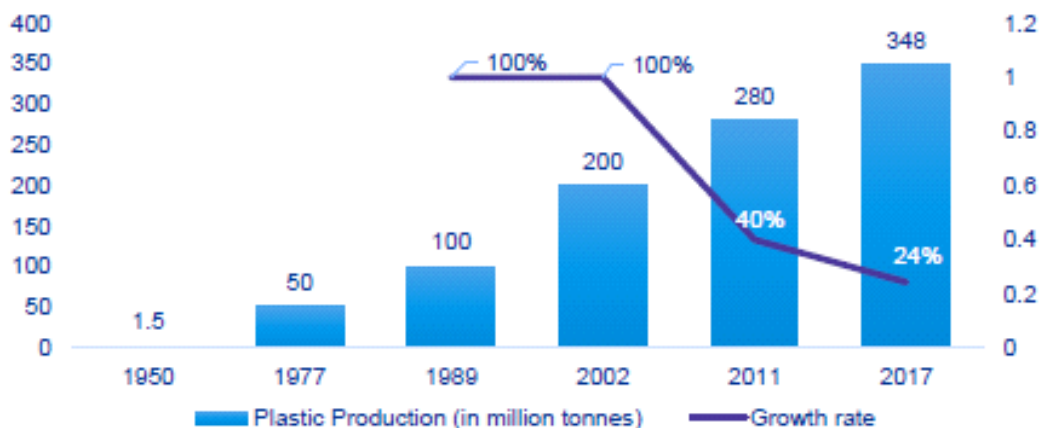
## 5. The production and consumption of Plastics –Global trajectory

In the sections above were presented some of the scientific features of plastics and polymer materials and key physico – chemical properties, the manufacturing and production and processing and fabrication aspects and the historic developments and evolution in the domain over decades. In the following sections we address the production and consumption features as

well as the issue of plastic waste and litter that has been leading to the problem of pollution and its impacts as being explored / analysed in a global and Indian contexts as aspects that are being further assessed as both – macroplastics and microplastics that are spreading in the environment and various media – including on the land and riverine and marine systems as a precursor to the chapters that address the specific issues of these problems that need solutions and interventions in various ways as further highlighted in the report.

#### **a) Global Production and Consumption of Plastics**

The production of plastics globally has seen a dramatic increasing trend since 1950s. The figure / chart 4.1 below highlights the growth features of the plastics industry. From about 1.5 Million Tonnes in 1950, global plastic production has risen to 348 Million Tonnes by year 2017 (i.e. over 232 times in just 67 years). The consumption levels of plastics, on per capita basis, in various regions of the world is presented in Table 2.8. Clearly the western world and European region is significantly high on plastics consumption ( 139 kg/capita and 136 kg/ capita) and India has as yet a moderate level of plastics consumption of 12 kg / capita. However, the developing world regions are steadily increasing plastics consumption, both from domestic production and via product imports and polymer / plastics imports. The world has seen a lifestyle shift and change in the course of modernisation and the problem of single use plastics has emerged a matter needing attention across the world. In further sections and as part of the report the plastic waste issues and their management and approaches being attempted also reflected upon as [part of the project undertaken.



**Figure 5.1 : Global Plastic Production trends (Kulkarni presentation, 2019)**

Table 4.6: The estimated consumption of plastics across regions

Sr.No	Region	Plastic Consumption in Kg per capita
1	NAFTA	139
2	Western Europe	136
3	Middle East and Africa	16
4	A003320sia	36
5	World Average	45
6	India	12

(Source : Kulkarni presentation, 2019)

## **b) The global production of plastic / polymer types and their use pattern**

As an assessment of data that has been collated and analysed by researchers / institutions studying trends in plastics production and consumption the details of key/ major types of polymers produced and their aggregate breakup vis a vis total production as of year 2015 is highlighted as part of Figure 4.2 (Source : <http://theconversation.com/the-world-of-plastics-in-numbers-100291> accessed 17 March 2020 as part of a report on the world of plastics in numbers).

It can be seen that while the production of polypropylene is the highest worldwide (upto 68 Million Tonnes as of year 2015), the other major polymers are also significantly close such as Low Density

Polyethylene at 64 Million Tonnes and HDPE (High Density Polyethylene of about 52 Million Tonnes). The levels of production of PVC (Poly Vinyl Chloride and Polyethylene Terephthalate) are comparable at 38 and 33 Million Tonnes respectively. At the next level are poly urethane resins and Polystyrene of about 27 and 25 Million Tonnes in year 2015. The additives production, that are utilised to blend with plastic polymers is in the range of 25 Million tonnes of production in 2015 and various other types of polymers make up the balance of about 16 Million Tonnes of production in 2015.

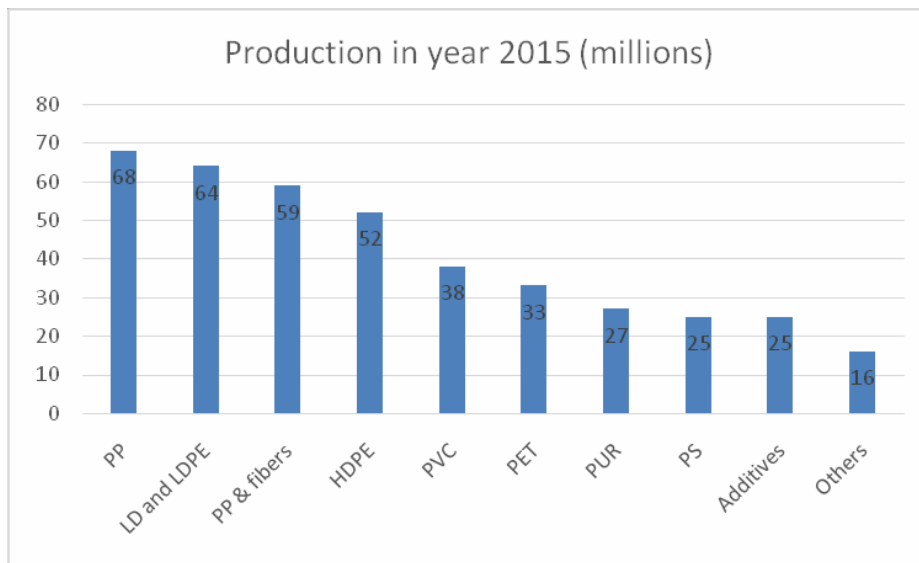


Figure 5.2: A reflection of various types of polymers production in Million Tonnes in year 2015 globally

(Source: <http://theconversation.com/the-world-of-plastics-in-numbers-100291> accessed 17 March 2020)

As it has been indicated in earlier sections that a significant amount of plastics and polymers are manufactured from non renewable petroleum resources, on a comparative scale the oil and gas uses for plastics is only about 4% as compared to 45% of its use for transportation and about 42% in heating and energy related applications etc, which are the main uses for petroleum products. The chart of the use of extracted oil and gas use on a global perspective is presented in Figure 4.3.

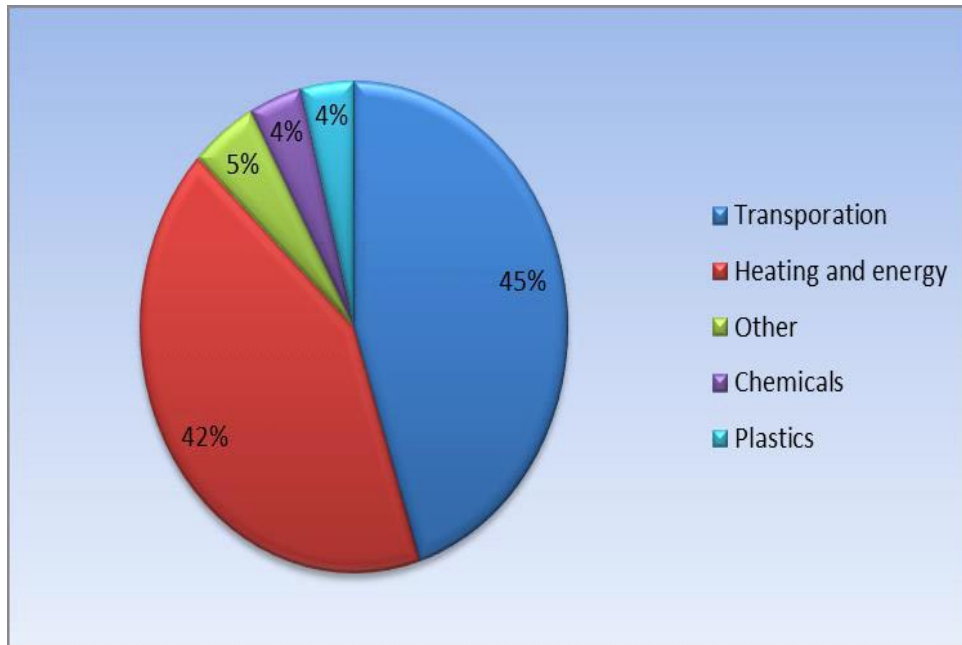


Figure 5.3: Application of Oil and Gas resources for major domains in a global perspective

(Source: <http://theconversation.com/the-world-of-plastics-in-numbers-100291> accessed 17 March 2020)

The usage of plastics globally in various sectors has also been estimated and presented in figure 2.16. It can be seen that plastics usage in packaging sector is the highest at about 35.9% as of year 2015. The use in building and construction sector is at the next level at about 16% and in textiles at 14.5%. It may be noted however that in specific country contexts the usage levels of plastics in various sectors can vary and the case of India is highlighted in further sections.

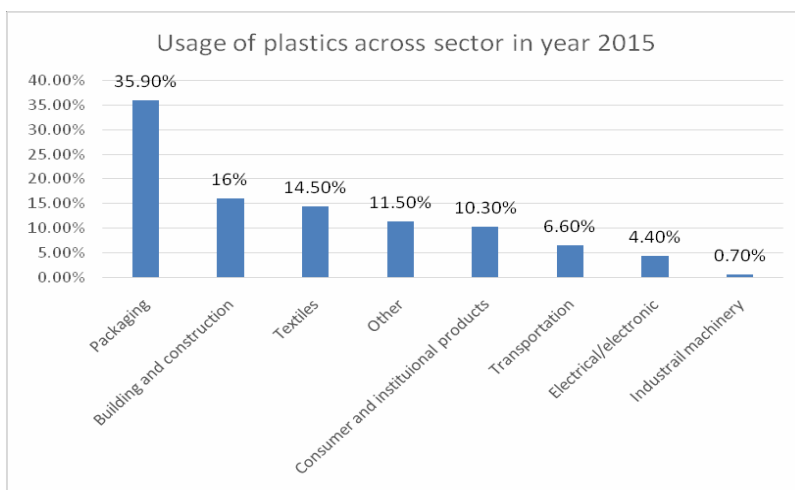


Figure 5.4 : The usage of plastics across sectors globally (year 2015)  
 (Source :<http://theconversation.com/the-world-of-plastics-in-numbers-100291>  
 accessed 17 March 2020)

## 6 The production and consumption of Plastics – Indian scenario

The status of production and consumption of plastics is highlighted in this section.

In India the production of various polymers during 2016-17 and 2019-20 and the aggregate plastics production is presented in **Table 5.1** in Kilo Tonnes. It is noticeable that there is a wide range of plastic polymers manufactured in India and that while polypropylene is the major polymer manufactured (35.91% of all plastics in 2019-20) and HDPE (18.08%), LLDPE (14.56%), PET (13.12%) and PVC (9.09%) as other key components as of 2019-20, there has been a significant rise in production of LDPE, with a growth increase by 195% from year 2016-17 levels. Further, as of 2019-20 over 75% of Plastics production in India is undertaken by the top five companies (amongst 18 key players), i.e. namely Reliance Industries (41.46%), Indian Oil Corporation Ltd. (12.67%), ONGC Petro Additions Ltd. (8.87%), Haldia Petrochemicals (6.97%) and GAIL (5.83%) as per India Plastics Industry Report.

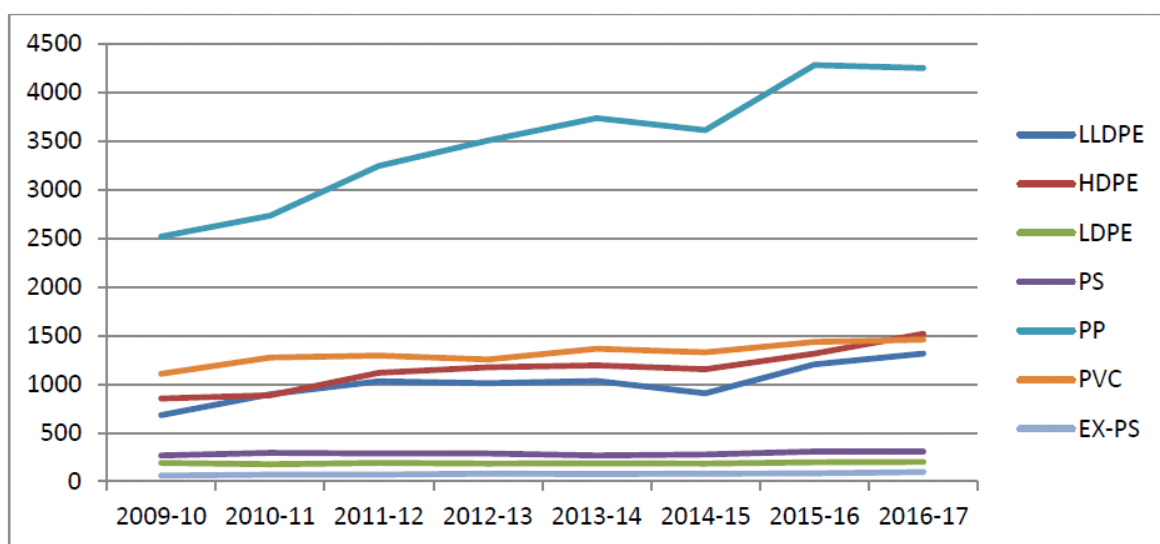
Table 6.1: Polymer Production in India in Kilo Tonnes per Annum (Plastindia Foundation)

Polymer	2016-17	2019-20	Percent Increase
---------	---------	---------	------------------

Polymer	2016-17	2019-20	Percent Increase
PS/EPS	599	599	0 %
LDPE	205	605	195.12%
LLDPE	1700	2300	35.29%
HDPE	2855	2855	0%
PP	4970	5670	14.1%
PET	2072	2072	0%
PVC	1435	1435	0%
Others	252	252	0%
Total	14088	15788	12.07%

Source: India Plastics Industry Report

The trends in production of key plastic polymers in India (for about an 8 year period from 2009-10 to 2016-17) had been reflected in TERI report (National Resource Efficiency Policy of India, TERI, April 2019) as reflected in Figure 6.1.



**Figure 6.1: Trend in production of key polymers in India in '000 Tonnes (Reference report on National Resource Efficiency Policy of India, TERI, April 2019)**

Source: Details available at

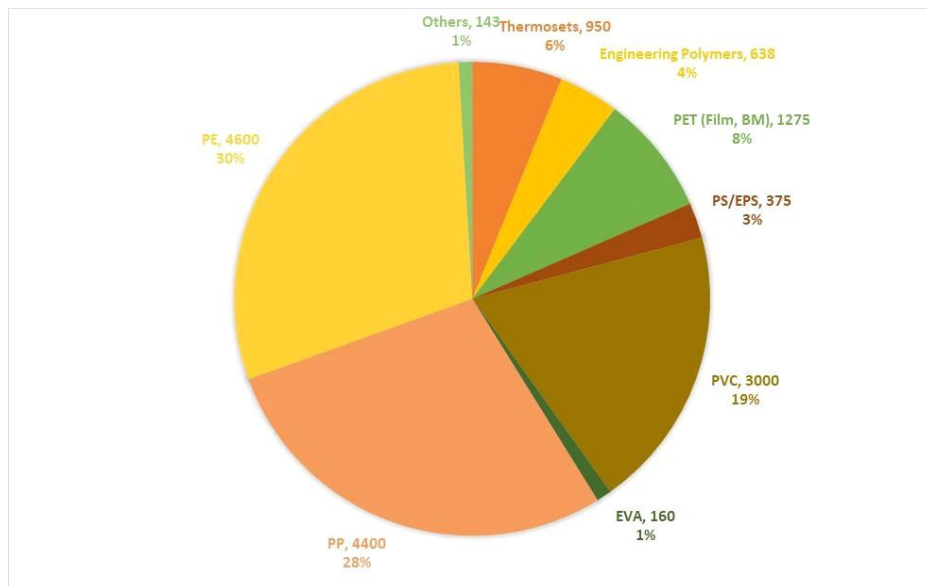
[https://chemicals.nic.in/sites/default/files/Chemical%20and%20Petrochemical%20Statistics%20at%20a%20Glance%20-2017\\_0.pdf](https://chemicals.nic.in/sites/default/files/Chemical%20and%20Petrochemical%20Statistics%20at%20a%20Glance%20-2017_0.pdf)

Table 6.2 : Indian Plastic Industry overview (Source : PIASTINDIA Foundation)



Virgin Polymer consumption in 16-17	15500 KT
India Per Capita Consumption (Virgin Polymer)	12 kg
No of Processing units	~40,000
No of processing Machines	~141,000
Processing Capacity	41200 KT
Processing Capacity CARG	11% last 5 years
No. of plastics machinery manufacturing units	~500
Investment in Machinery	~USD 5 Bn
Investment required for next 5 years	~USD 4.37 Bn (Projected)

The polymer wise consumption of plastics in India is depicted in **Figure 6.2**. It is evident that Polyethylene, Polypropylene, Poly Vinyl Chloride and Polyethylene Terephthalate are the major polymers being consumed. In the Others category are included CPVC (110 KTA), TPE (18 KTA) and TPU (15 KTA). The next Figure 6.2 presents the break up of Thermoplastics and Thermosetting polymers that was being consumed in India during 2016-17.



**Figure 6.3 : Polymer wise consumption (in Kilo Tonnes per Annum) in India in 2016-17**

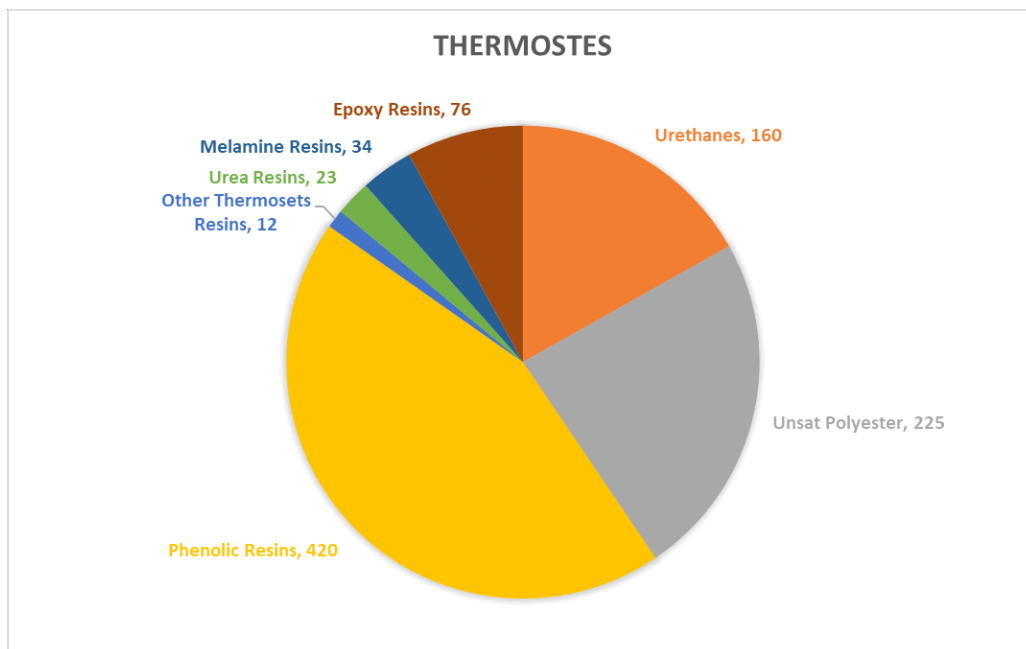
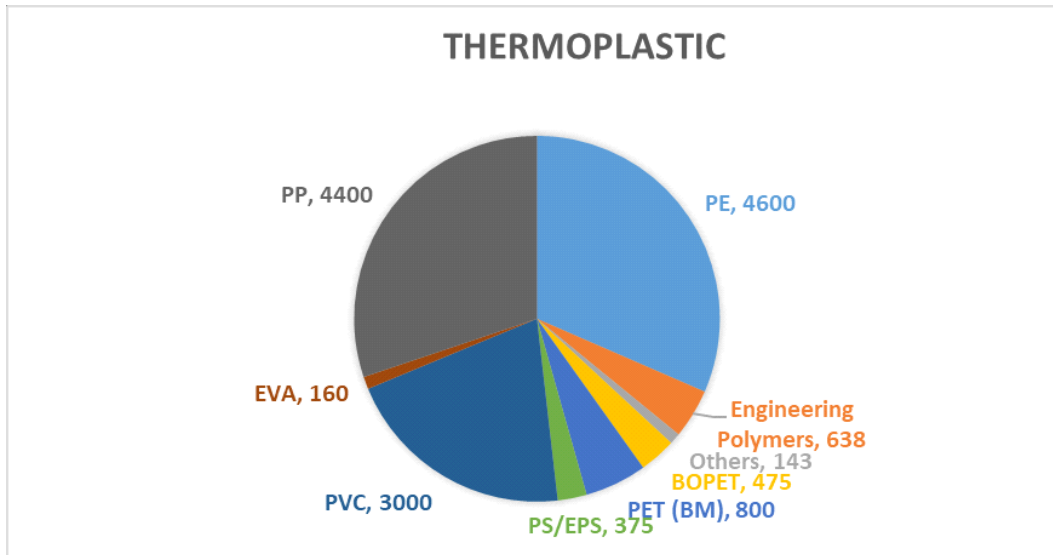
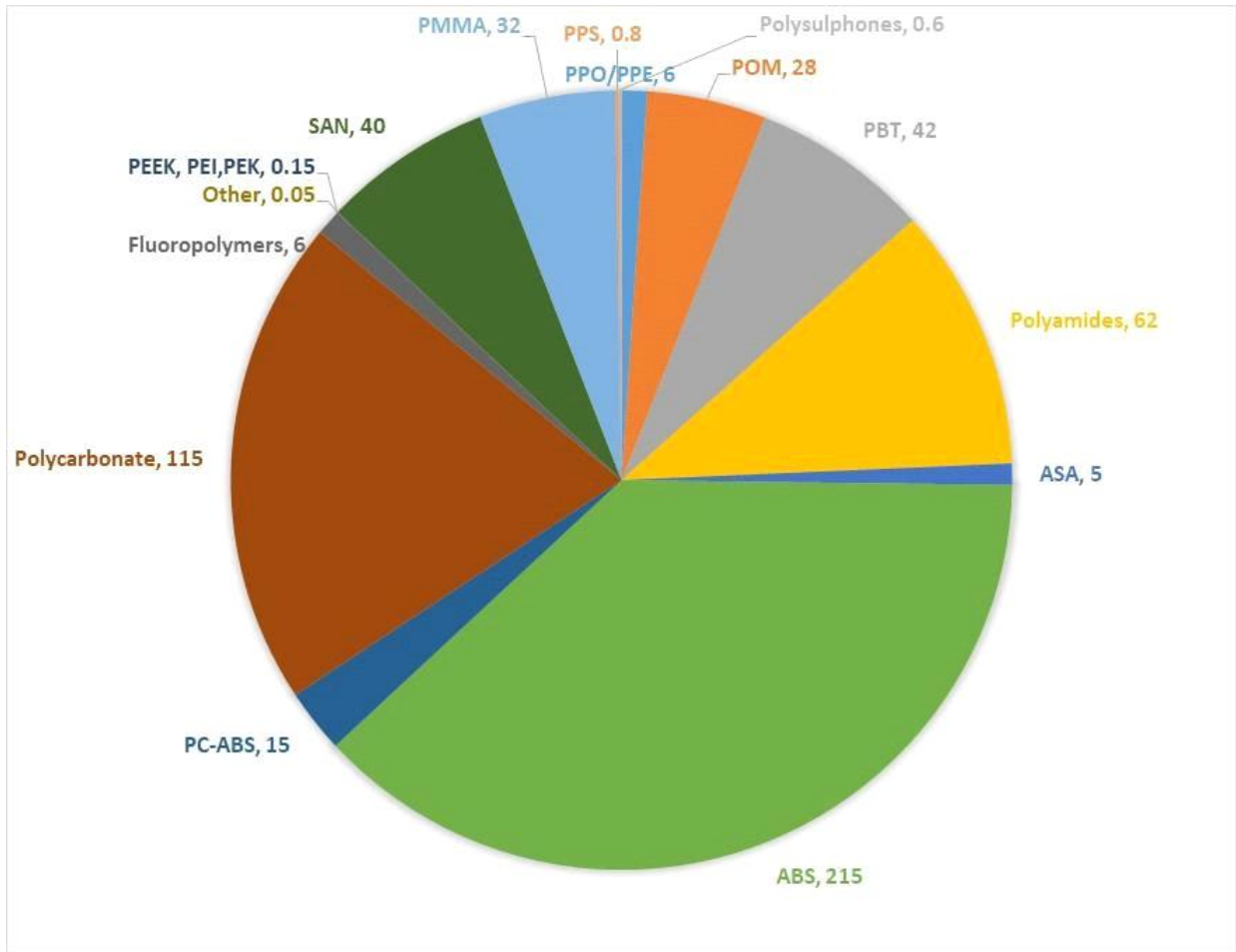


Figure 6.3 a and b: Polymer wise consumption (Thermoplastics and Thermosetting type) (in Kilo Tonnes per Annum) in India in 2016-17 (Source: PLASTINDIA Foundation). Further information is that Thermoplastics consumption grew to 18910 KT and Thermosetting Polymer consumption grew to 1090 KT in 2019-2020

Further, the Engineering Plastics consumption in India is depicted in Figure 6.3 which reflects the status in year 2016-17 in Kilo Tonnes for India ( Note : 638 Kilo Tonnes in 2016-17 which has grown to 819 Kilo Tonnes in 2019-20) @ 9% CAGR. In this set Consumption of Polycarbonates, ABS, and Poly Amides are most significant, besides others, all of whom have key product applications. Further, the high end Engineering Polymers production in India is depicted in table 2.18. It has been indicated that most of this is exported and about 10-15% is consumed in India.



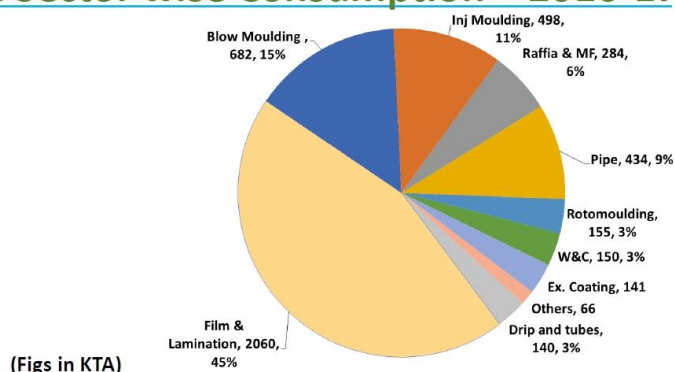
**Figure 6.4: Engineering Plastics Consumption in India in Kilo Tonnes in 2016-17**

Table 6.3 : High End Engineering Polymers Production in India by selected companies (PLASTINDIA Foundation)

Manufacturer	Plastics		Capacity (TPA)	Major Application
Solvay specialities (Panoli)	Polyether (PES)	Sulfone	2000	Chip trays, Electricals, membranes
	Polyether Ether Ketone (PEEK)		1000	Stock shapes, E & E, cables, gen. engineering, oil & gas
Solvay/Rallis (Ankleshwar)	Polyether Ketone (PEKK)	Ketone	110	CF composites for aerospace

Manufacturer	Plastics		Capacity (TPA)	Major Application
Gharda chemicals (Ankleshwar)	Polyether (PEK)	Keton e	100	Stock cable, engineering shape, gen.
	Polyether Ketone Ketone (PEKK)		50	Electronics, oil fields, Gen. engineering, 3D printing
	PolyBenzimidazole (ABPBI)		25	Blends with PEK, fire resistant fiber, membrane for high temp fuel cells

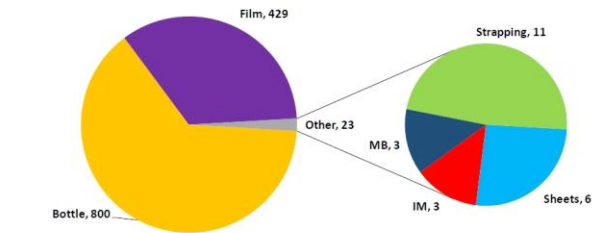
## PE Sector wise Consumption – 2016-17



PE : Demand – 4600KT (2016/17) – 5900KT (2019/20) : ~9% CARG

The sector wise consumption of the aggregate PE, PP, PET and OVC that is manufactured or imported to India is reflected in **Figures 6.5 a** and **6.5 b** and overall broad sector wise consumption of aggregated plastics put together is reflected in **Figure 6.5 c**. Polyethylene consumption has been maximum for film and lamination use and for blow molding activity and related products. Polypropylene is significantly routed into injection molding and Raffle related production system.

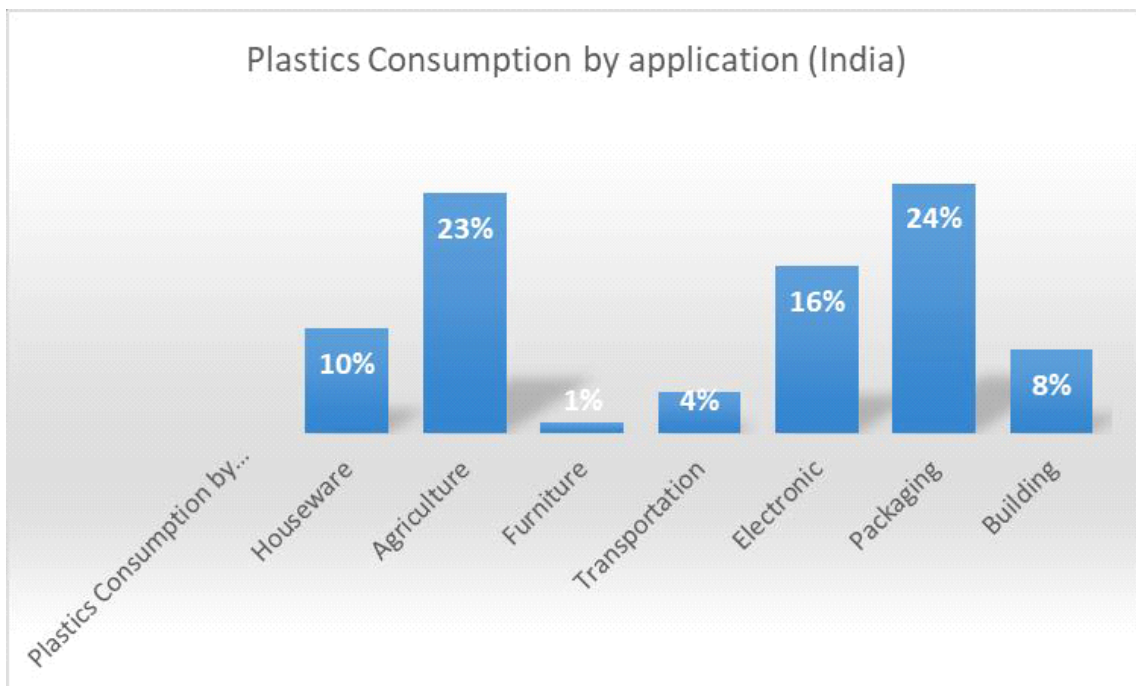
## PET Sector wise Consumption – 2016-17



(Figs in KTA)

PET : Demand – 1275KT (2016/17) – 1650KT (2019/20) : ~9% CARG

As reflected in **Figure 6.5 b**, it is to be noted that Polyethylene Terephthalate is majorly utilised for bottle production which are utilised by mineral water supply and beverage manufacturing units as the core packaging units in view of the important properties highlighted in earlier sections. A significant amount of PET is also used for films making that are used for various products related packaging applications. In India the most significant application of Poly Vinyl Chloride (PVC) is in the manufacturing of pipes for conveyance not only for water in the community and industry, but also for conveyance of a wide spectrum of chemicals in liquid form in the industry, besides the important application as insulator of electric wires and cables.



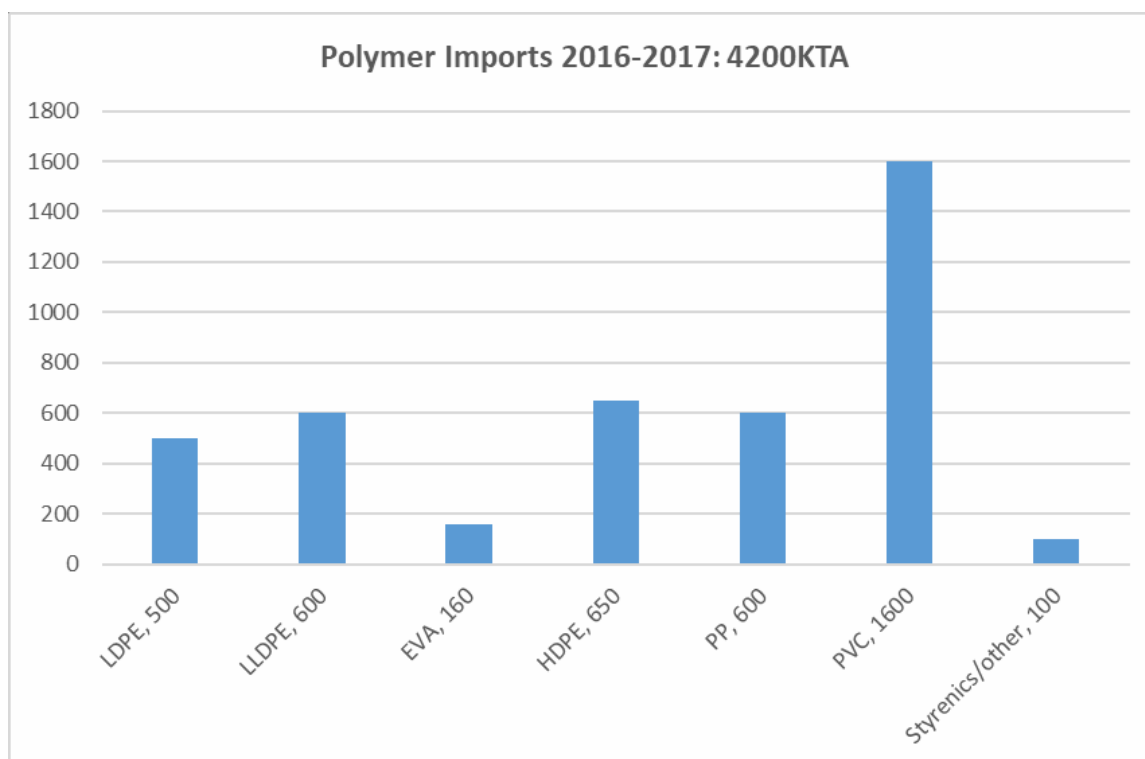
### Figure 6.5 c: Plastics consumption by application in India

(Source: EU – REI, 2018 (Adelphi - EPR) Reference report on National Resource Efficiency Policy of India, TERI, April 2019)

It is visible here that packaging, agriculture and electronics are found to be major domains where plastics consumption is identified.

#### 1.20 Imports and Exports of Polymers and Finished Plastic Goods with respect to India

The international trade in polymers and plastics related products by India is reflected further. It is to be noted that India imported 4200 Kilo Tonnes of Plastic polymers in 2016-17 as per the polymer wise break up indicated in **Figure 6.6**.



**Figure 6.6: Polymer imports by India in 2016-17 (PLASTINDIA Foundation)**

The quantum of imports of polymers was about 4200 Kilo Tonnes as of 2016-17, which was approximately 29.81% of the quantum manufactured in India in 2016-17. The import basket included all the key varieties of plastics such as PVC, PP, HDPE, EVA, LLDPE, LDPE, Styrenics and others. The

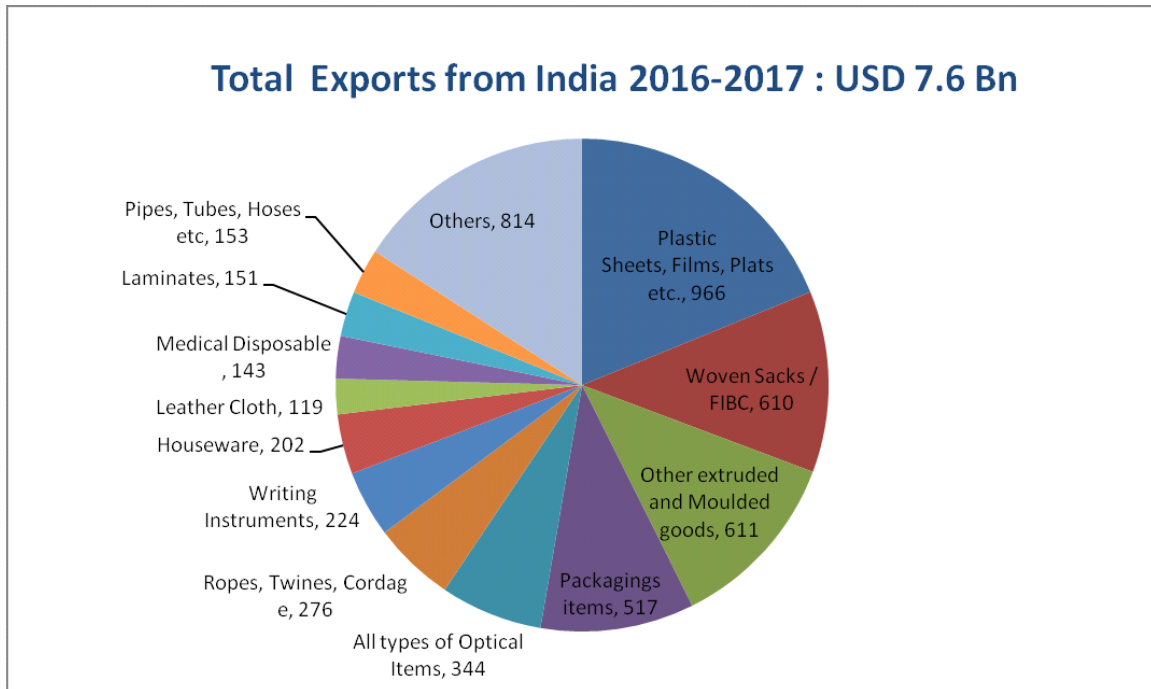
maximum percentage of imports amongst polymer types has been PVC which accounted for about 38% in 2016-17.

In the context of finished plastic goods import by India in 2016-17, the value of imports was in the range of USD 3.7 Billion. The product streams imported by India included plastic sheets and films and Plats (accounting for 33.11% of the value of imports) , packaging materials (7.835% in value terms), moulded and extruded goods (35.16% in value terms) and other items (23.88 % in value terms), while the main countries from where India imported plastics included China, USA, Korea, Germany, Japan, Italy, Thailand, Taiwan, France and Hong Kong.

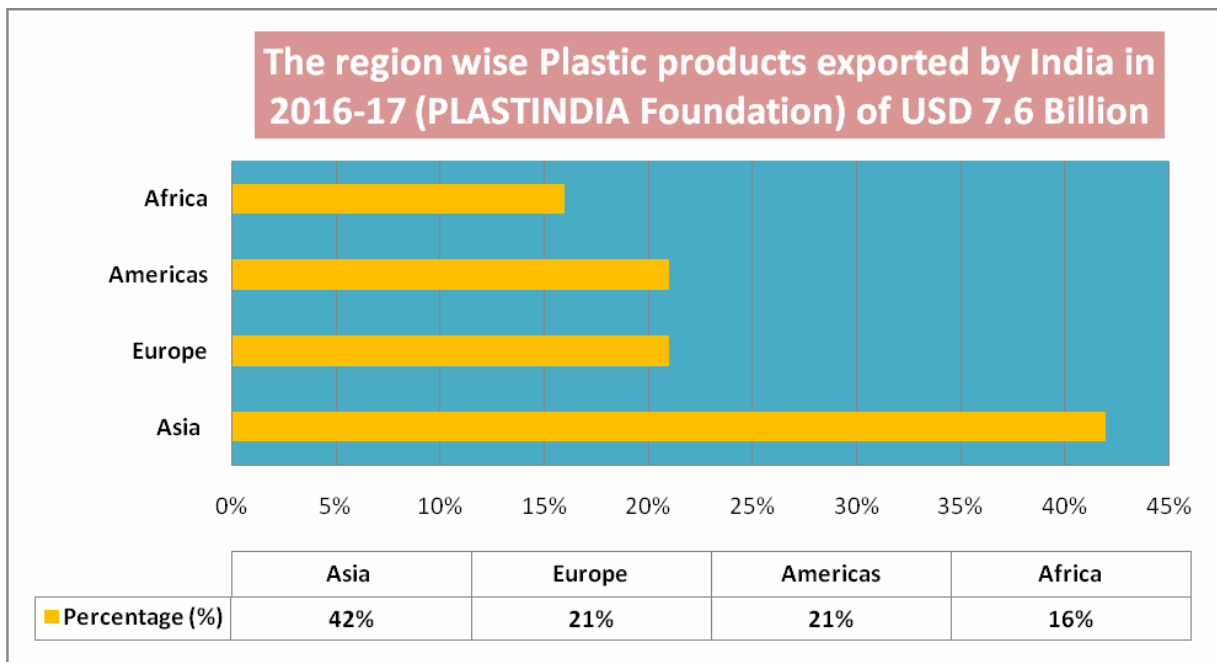
The spectrum of finished plastics based goods that India has been importing include Moulded and Extruded goods, LED Luminaires, Shapes and profiles, writing instruments, floor coverings, PVC fabricated goods, Ropes / Twines / Yarn and bristles, Fish nets and fishing lines, pipes and fittings, sheets and film, laminates, poly-lined jute goods, moulded and soft luggage items, lenses, FRP products, various electrical accessories, bangles and imitation jewellery, optical goods, solar PV modules, Cine X-Ray films, and Toys / Dolls and games etc.

As regards plastics products exports from India the outline is as per **Figure 6.7.** and **Figure 6.8 a** and **b**. According to the data a wide range of products are exported and the value of exports has been in the range of USD 7.6 Billion as of 2016-17. There is a wide range of products that India is capable of exporting and the major continents India exports include Asia, Europe, Africa and Americas. The polymers that India primarily exports include Polyethylene Terephthalate (PET), Polypropylene (PP), LLDPE and Polystyrene (PS).

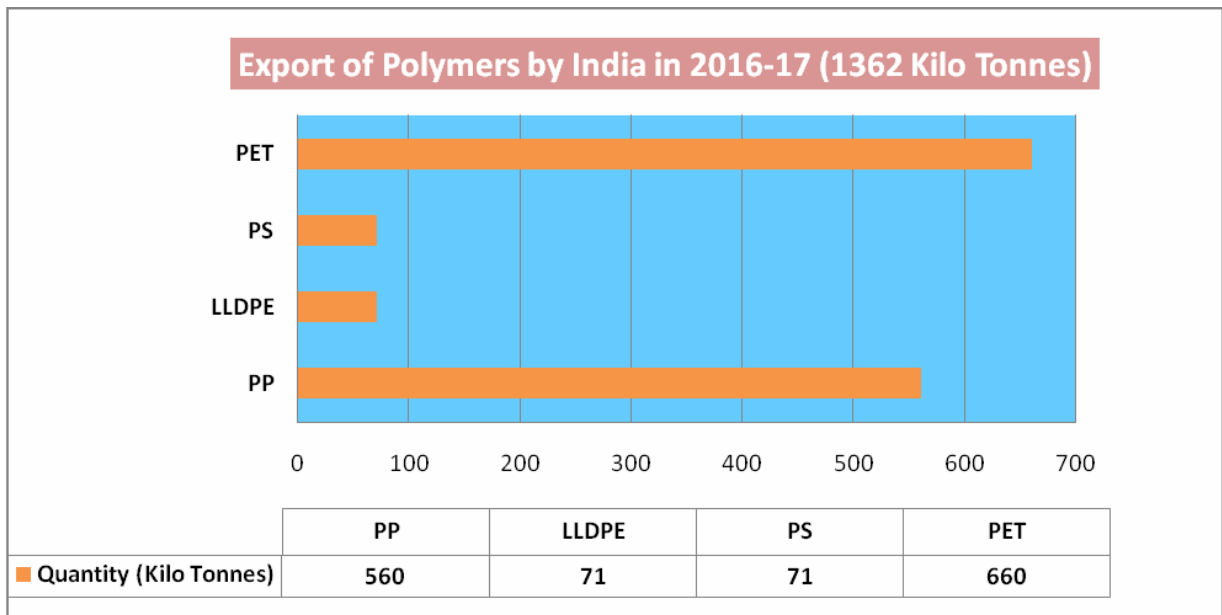




**Figure 6.7: Plastic Products exported by India in 2016-17 (PLASTINDIA Foundation)**



**Figure 6.8 a: The region wise Plastic products exported by India in 2016-17 (PLASTINDIA Foundation) of USD 7.6 Billion**



**Figure 6.8 b: Export of Polymers by India in 2016-17 (1362 Kilo Tonnes)**

### **The mean service life of plastics in the hands of the consumers**

In the context of plastic waste generation, one of the features that is an indicator of plastic waste generation is the life of plastic products in the consumption stages and cycle and a comparison of the mean service life in years has been estimated and compared between India and Germany from a broad product life distribution from 0 to less than or equal to 3 years which for India has been estimated to be for about 61% of the products where plastics applications occurs and in Germany it has been estimated to be 32% which is about 50% of the products compared to India in this life range. Further, is the percentage of products in the greater than 3 years to 10 years or less and for greater than 10 years (especially for plastics components that are pure or composite plastics or those plastics components as well that are parts of products having other materials (a significant amount of which would include the electrical and electronic goods). Table 2.14 presents this perspective and comparison as identified in a Centre for Science and Environment Report that cites the source as Nitin H. Mutha et al (2006).

Table 6.4: Service Life of Plastic products (Reference CSE report and Nitin H.

Mutha et al., 2006)

Mean service life (years)	Share of product with different service life (percent)	
	India	Germany
0 to < 3	61	32
>3 to <10	23	39
>10	16	28

Source: Nitin H. Mutha, Martin Patel, V. Premnath, *Plastics material flow analysis for India*, Elsevier, *Resources, Conservation and recycling* 47, 2006, p.222-244

## 7 Indicative Plastics Waste quantum and their variety in Electronics Waste and Auto Waste in India

As per presentation made by CIPET citing the relevant sources regarding the composition of e-waste and auto – waste in India with indications of the plastics waste content in these sub-sectors and of the nature of plastic waste polymers as well, we observe the key features as per tables below. As per the assessments being made in the context of Plastics content in Electronic wastes and Plastics in

Auto Waste the compositions being found on average are as follows as indicated in **Tables 7.1** and **Tables 7.1 a** and **b**.

Table 7.1: Composition of key materials in E-Wastes

Sr. No.	Nature of Material / Components	Percentage in Electronic Waste
1	Ferrous materials	36%
2	Aluminium	5%
3	Copper	3%
4	Other metals	1%
5	Plastics	12%
6	Brominated plastics	18%
7	Lead glass	19%
8	Others	6%

(Source: *Inventorisation of E- Waste and Developing a policy – Bulk Consumer perspectives, 2016*; Xiaoning Yang “Pyrolysis and dehalogenation of plastics from waste electrical and electronic equipment (WEEE) – A review – 2013)

It has been further indicative that the nature of plastics in Electronic goods / electronic wastes include the spectrum such as ABS, HPS, PC, PC/ABS, PP, PPE+HIPS, PVC, PS, PA, PBT etc.

Table 7.1 a: Indicative composition of Key materials in Auto Waste (Materials in End of Life Vehicles) as per Presentation by CIPET and citing

Sr. No.	Nature of material / component	Percentage in Electronic Waste
1	Ferrous and other metals and non - metals	72%
2	Plastics	15%
3	Glass	3%
4	Tyres	3%
5	Fluids	2%
6	Others	5%

Source: Xiaoning Yang, 2013

Table 7.1 b: On average or indicative plastics in End of Life Vehicles as per Presentation by CIPET and citing

Sr. No.	Nature of material	Percentage in Electronic Waste	Main types of Plastics
1	Bumpers	22%	PS, ABS, PC/PBT, PP
2	Dash Boards	13%	PP, ABS, SMA, PPE, PC
3	Seat cushions / upholstery	10%	PVC, PUR, PP, PE
4	Fuel tank /system	8%	HDPE, PA, PP, PBT
5	Battery and under bonnet components	5%	PA, PBT, PP
6	Others (including Electrical components, interior and exterior trim, lighting, liquid reservoirs etc)	42%	PP, ABS, PET, POM, PVC, PBT, PA, PMMA, PE, PUR etc., as per application requirements

Source : Xiaoning Yang, 2013

## 8 The potential for growth of plastic Industry in India

The growth of the plastic industry and its contribution to the economic system is continuing to be on the upward trend globally, as well as in India, as life style changes spread and technological advancements along with modernisation broadens and demand for goods and services expands with economic growth. It has been especially identified that the major growth drivers are likely to be packaging (for food products and others), infrastructure related applications, agriculture applications, consumer durables, healthcare, Solar PV and other areas.

As per indications in PlastIndia report and assessments, in the packaging sector the plastics applications are likely to increase for multilayer films, BOPP films, shrink and stretch wraps, thin wall molding, thermoforming and blow molded containers. In the domain of infrastructure pipes (gas, water supply, sewerage, plumbing others), storage tanks, geotextiles and geomembranes, wires and cables related applications will be growth drivers. In the field of agriculture the applications shall include greenhouse films, micro-irrigation requirements (drip / sprinklers), mulch films and crates and pallets etc. In the domain of consumer durables the applications include a vast spectrum of appliances and devices, further furniture and toys, luggage and houseware etc. In the healthcare sector the applications that shall grow include heart valves, prosthetics, spectacles, hearing aids and more, further packaging of medicines and fluids, and a spectrum of disposable products such as syringes, IV bags, blood bags, diapers, bed covers and linen, masks and gloves. Other key growth areas include rigid packaging, automotive, 3D printing, industrial components, solar PV and, LED lights etc.

To cater to the demand of plastics India has focused on development of plastics parks and the following **Table 8.1** highlights the same and their distribution geographically.

Table 8.1: Plastic Parks - Existing and Proposed Geographic distribution (PlastIndia report)

Plastic Parks	Area (Acres)
Sanand, Gujarat	140
Dahej, Gujarat	100
Narasapura, Karnataka	100
Auraiya, Uttar Pradesh	225
Tamot, Madhya Pradesh	150
Siju Village, Odisha	120

Barjora, West Bengal	496
Ibrahimpattanam, Telangana	500
Kannur, Kerala	TBC
Tinshukla, Assam	600
Chennai, Tamil Nadu	300
Panipat, Haryana	TBC

In view of the projection of polymer consumption to rise beyond 20 Million Tonnes in India and the growth rate of machinery installed capacities occurring at over 11.1% CAGR and the scope and process of global companies investments to rise in India with policy instruments being applied with regard to duties and levies being moderated for plastics sector, the growth process is likely to be strengthened and buttressed and resulting from the plastics growth, will arise the problem and issues concerning plastic waste generation and its management. The sections ahead reflect on the problem of plastics pollution and leakage into the environment, and the aspects concerning management and initiatives arising and further needed in future.

### Brand names and branded Plastics

There is a range of plastics and polymers that have been branded and a list is presented below reflecting polymers, properties and uses ([https://en.wikipedia.org/wiki/List\\_of\\_synthetic\\_polymers](https://en.wikipedia.org/wiki/List_of_synthetic_polymers) accessed 26 Feb 2020).

Table 8.2: A list of branded plastics

Brand Name	Polymer	Characteristic properties	Uses
<b>Bakelite</b>	Phenol-formaldehyde resin	High electric, heat and chemical resistance	Insulation of wires, manufacturing sockets, electrical devices, brake pads, etc.
<b>Kevlar</b>	Para-aramid fibre	High tensile strength	Manufacturing armour, sports and musical equipment. Used in the field of cryogenics
<b>Twaron</b>	Para-aramid	Heat resistant and strong fibre	Bullet-proof body armor, helmets, brake

Brand Name	Polymer	Characteristic properties	Uses
			pads, ropes, cables and optical fibre cables, etc. and as an asbestos substitute
<b>Mylar</b>	Polyethylene terephthalate film	High strength and stiffness, less permeable to gases, almost reflects light completely	Food packaging, transparent covering over paper, reflector for rollsigns and solar cooking stoves
<b>Neoprene</b>	Polychloroprene	Chemically inert	Manufacturing gaskets, corrosion resistant coatings, waterproof seat covers, substitute for corks and latex
<b>Nylon</b>	Polyamide	Silky, thermoplastic and resistant to biological and chemical agents	Stockings, fabrics, toothbrushes. Molded nylon is used in making machine screws, gears etc.
<b>Nomex</b>	Meta-aramid polymer	Excellent thermal, chemical, and radiation resistance, rigid, durable and fireproof.	Hood of firefighter's mask, electrical lamination of circuit boards and transformer cores and in Thermal Micrometeoroid Garment
<b>Orlon</b>	Polyacrylonitrile (PAN)	Wool-like, resistant to chemicals, oils, moths and sunlight	Used for making clothes and fabrics like sweaters, hats, yarns, rugs, etc., and as a precursor of carbon fibres
<b>Rilsan</b>	Polyamide 11 & 12	Bioplastic	Used in high-performance applications such as

Brand Name	Polymer	Characteristic properties	Uses
			sports shoes, electronic device components, automotive fuel lines, pneumatic airbrake tubing, oil and gas flexible pipes and control fluid umbilicals, and catheters.
<b>Technora</b>	Copolyamid	High tensile strength, resistance to corrosion, heat, chemicals and saltwater	Used for manufacturing optical fiber cables, umbilical cables, drumheads, automotive industry, ropes, wire ropes and cables
<b>Teflon</b>	Polytetrafluoroethylene (PTFE)	Very low coefficient of friction, excellent dielectric properties, high melting, chemically inert	Plain bearings, gears, non-stick pans, etc. due to its low friction. Used as a tubing for highly corrosive chemicals.
<b>Ultem</b>	Polyimide	Heat, flame and solvent resistant. Has high dielectric strength	Used in medical and chemical instrumentation, also in guitar picks
<b>Vectran</b>	aromatic polyester	High thermal and chemical stability. Golden color. Has high strength, low creep, and is moisture resistant	Used as reinforcing fibres for ropes, cables, sailcloth. Also used in manufacturing badminton strings, bike tires and in electronics applications. Is the key component of a

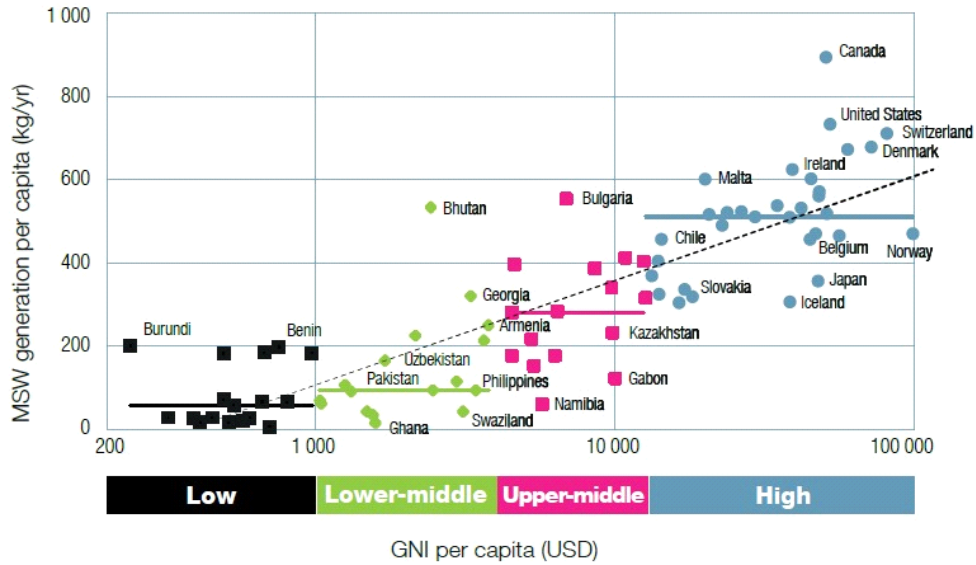


Brand Name	Polymer	Characteristic properties	Uses
			line of inflatable spacecraft developed by Bigelow Aerospace
<b>Viton</b>	Polytetrafluoroethylene (PTFE)	Elastomer	Depends on the grade of the polymer. Viton B is used in chemical process plants and gaskets.
<b>Zylon</b>	poly-p-phenylene-2,6-benzobisoxazole (PBO)	Very high tensile strength and thermal stability	Used in tennis racquets, table tennis blades, body armor, etc.

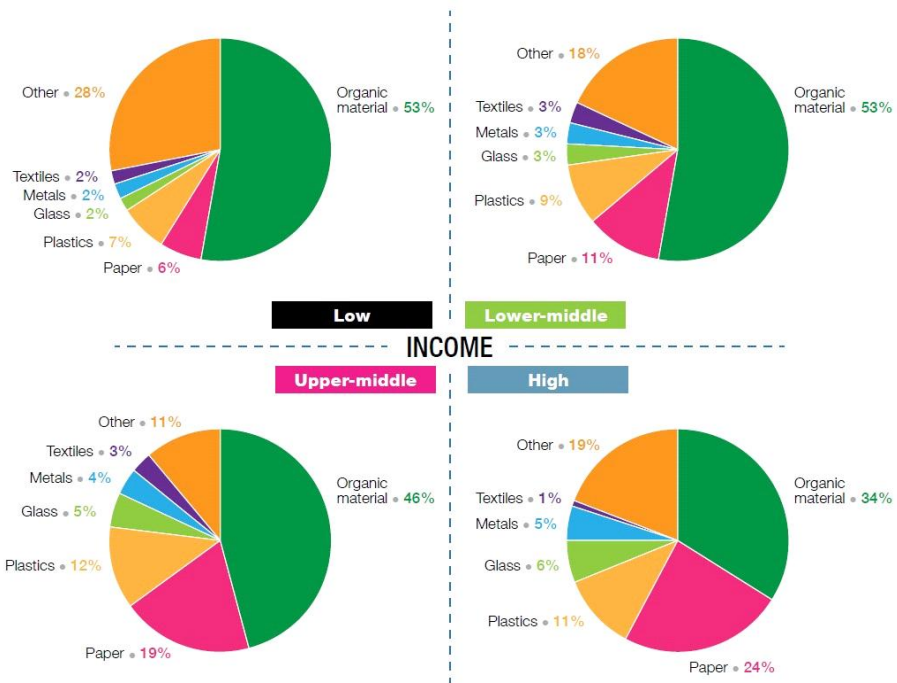
## 9 Plastics Waste generation and Leakage in the Global context and the multidimensional pollution challenge

As per UNEP (2015) Report, titled 'Global Waste Management Outlook', the best 'order of magnitude' estimate of total global arisings of Municipal Solid Waste is around 2 Billion Tonnes per annum. Further, a broad grouping of 'Urban' wastes globally, including Municipal Solid Wastes, Commercial and Industrial Wastes (C & I), Construction and Demolition Waste (C&D) etc, is estimated at around 7 to 10 Billion Tonnes per annum.

It has been indicated that although waste generation rates vary widely within and between countries, the generation rates per capita of the several waste streams is strongly correlated with national income (Figure 9.1). Further, the insight on waste composition is indicative of the nature of waste components including plastics waste as percentage of the municipal waste streams, and the general scenario as a reference for different income levels across the world is presented in Figure 9.2. It is observed that plastics waste content varies from 7% to 12% in the Municipal waste stream of Low income countries and upper middle income countries respectively. In the high income countries it is estimated at 11% of plastic waste in the municipal waste stream.



**Figure 9.1: Waste Generation versus income level by country (UNEP, 2015)**



**Figure 9.2: Variation in MSW composition grouped by country income levels (UNEP, 2015)**

Further estimates of plastic waste generation on a global perspective on the basis of industrial sectors has been indicated to be 302 Million tonnes for year 2015 as reflected in Figure 9.3. This estimate of plastic waste

generated in 2015 when compared to the total municipal waste generation in 2015 of about 2 Billion Tonnes is indicative of an average of 15.1% of plastic waste generation levels as a reference value as well from a global perspective. As per figure 9.3 it can be seen that packaging sector, as anticipated, generated the maximum plastic waste, which amounted to approximately 46.69% in 2015 within reference to the range of total estimated plastic waste of 302 Million Tonnes.

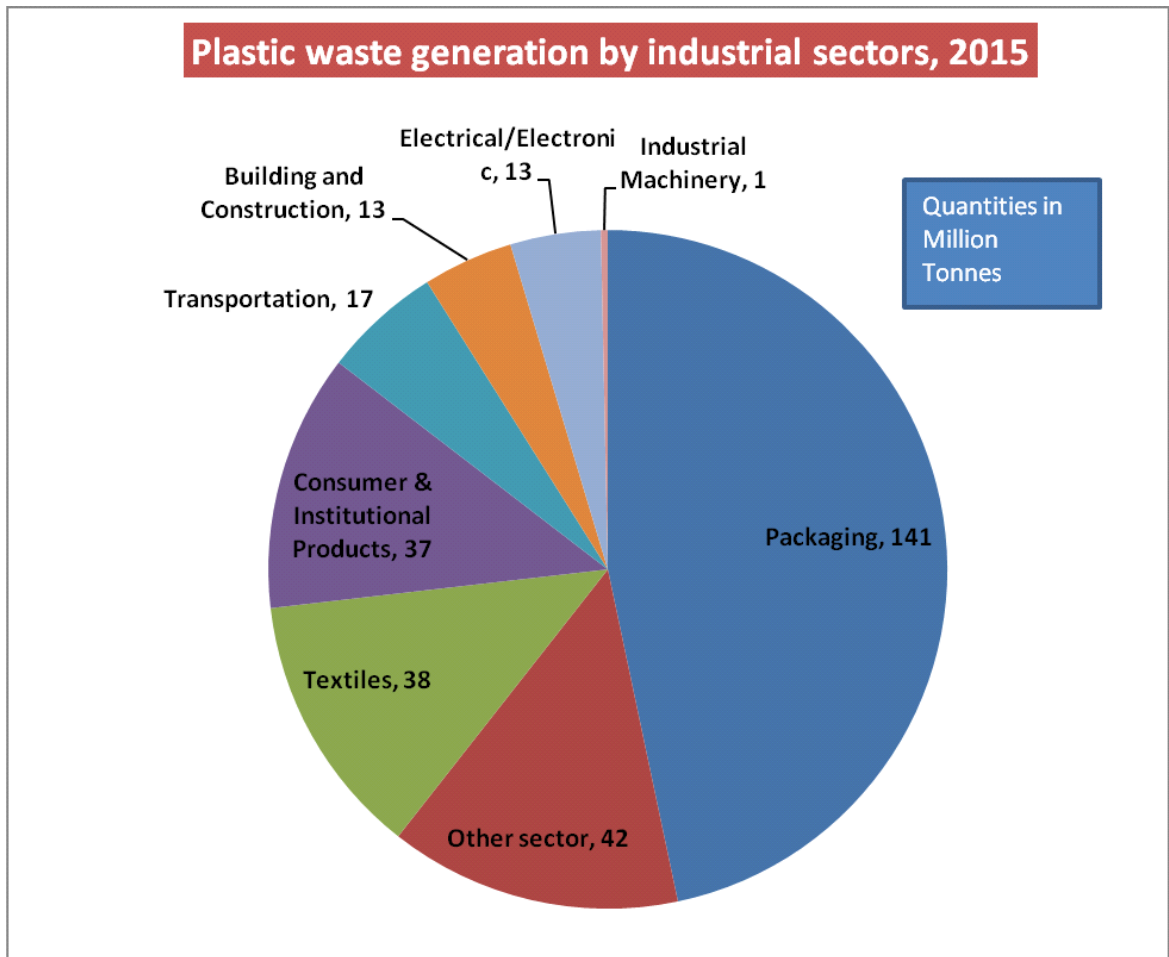


Figure 9.3: An overview of plastic waste generation by industrial sector as of year 2015

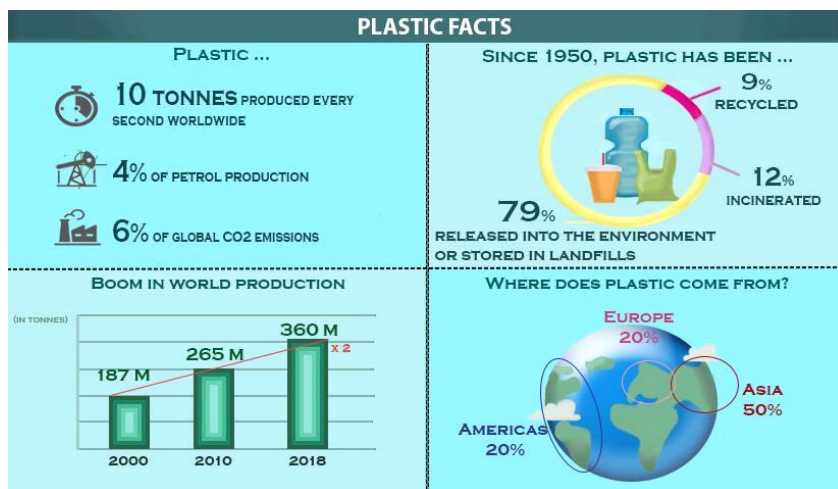
## 10 The Plastic waste leakage perspective and plastic pollution in the marine environment

Studies, estimates and research carried out by various researchers have led to the exploration and estimation of plastic leakage into the environment as well.

Global plastic leakage is estimated in the order of 10 million tonnes per year (Mt/y), with different authors presenting different yearly values.

- 4.8 Mt/y to 12.7 Mt/y (Jambeck et al. 2015)
- 8.28 Mt/y (UN Environment, 2018)
- 12.2 Mt/y (EUNOMIA, 2016)
- 10 Mt/y (Boucher and Friot, 2017).

In view of the above varying estimates, it is indicative that significant additional focused studies are required to assess the plastic waste generation data at micro level across countries and aggregating the same at national and international levels, as well as study and estimate plastics leakage into the environment at micro and macro levels, which could help obtain local and global insights on the nature and features and causes and effects of plastics leaking into the environment and to develop counter measures to better manage the growing problem. It has been further estimated that of the total plastic waste generated through history, especially since 1950, about 79% has been released into the environment or stored in landfills. Further, about 9% of the total plastic waste generated since 1950 about 9% has been recycled and about 12% incinerated. This is reflected in **Figure 10.1**.



**Figure 10.1: The breakdown of produced plastics that have accumulated in the environment**  
(Source-Crédit Agricole)

The estimates accordingly made for total plastics that has reached the oceans globally over the period since 1950s till date has been indicated to be 150 Million Tonnes. Another key feature that has been identified in the items recovered in coastal areas cleanup exercises across countries is that about 62% of this comprises of plastics packaging. Estimates and projections had been made that in the year 2014, about 1 kg of plastics was in the oceans for every 5 kg of fish and that this was expected to grow to the extent (from business as usual scenarios) that plastics quantum could exceed the mass of fishes in by 2050 (Ref. Presentation by CIPET). The contribution of the different sources of plastic waste generated towards leakage of plastics has also been mapped and reflected in **Figure 10.2**. This shows that there is approximately 3% leakage of plastic wastes globally (of approximately 12 Million Tonnes per year) and highlights the main sources together with their most frequently cited quantities (green pie chart), in comparison to the global amounts of plastic produced (orange pie chart) of approximately 415 Million Tonnes per year.



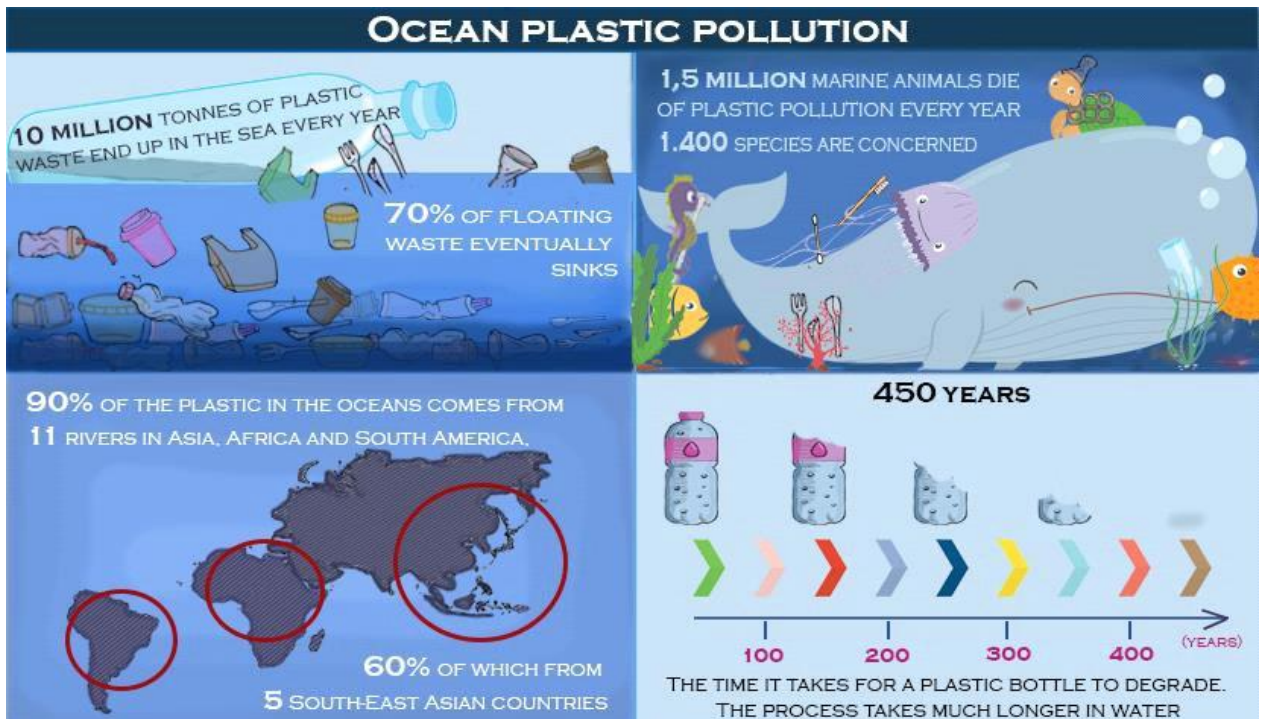
**Figure 10.2 : Plastics waste leakage scenario**

(Source- Boucher et al. in press; IUCN – The marine plastic footprint)

A higher estimate has been put forward by the World Economic Forum, with an estimated 32% of single-use packaging escaping collection systems (WEF, 2016).

## 11 Plastic Pollution – The estimates, impacts on marine biota and macro / micro distinctions

Plastic pollution is the accumulation and spread and aggregation too of plastic objects and particles (e.g. plastic bottles, bags and microbeads) in the Earth's environment that adversely affects wildlife, wildlife habitat, and humans ( Encyclopaedia Britannica; Laura Parker, June 2018; [https://en.wikipedia.org/wiki/Plastic\\_pollution](https://en.wikipedia.org/wiki/Plastic_pollution) accessed 19 March 2020). A significant amount of the plastic pollution is being found in marine environment and the seas. The **Figure 11.1** indicates the problem and its assessments that is becoming a growing concern.



**Figure 11.1: Oceanic Plastic Pollution (Source-Crédit Agricole)**

It is indicative and widely observed that plastic pollution can afflict land, waterways and oceans. The estimates being made reflect the same, and it has been also indicated in the context of marine environment and pollution of oceans that about 1.1 to 8.8 million tonnes of plastic waste enters the ocean from coastal communities each year (Jambeck et al., 2015). And as per an assessment reflected on World Oceans Day : 5 Trillion Pieces Of Plastic is Floating In World's Oceans (<https://swachhindia.ndtv.com/world-oceans-day-5-trillion-pieces-of-plastic-floating-in-worlds-oceans-8548/> accessed 23 March 2020).

Further, it is indicative that living organisms, particularly marine animals, can be harmed either by mechanical effects, such as entanglement in plastic

objects, problems related to ingestion of plastic waste, or through exposure to chemicals within plastics that interfere with their physiology. Effects on humans include disruption of various hormonal mechanisms.

As regards the estimates it is highlighted that as of 2018, about 380 million tonnes of plastic is being produced worldwide each year, and that from the 1950s up to 2018, an estimated 6.3 billion tonnes of plastic has been produced globally, of which an estimated 9% has been recycled and another 12% has been incinerated (The Economist). Further, a large amount of plastic waste enters the environment (other than the plastics not contained in the products in use or under consumption and as yet not disposed), with studies suggesting that the bodies of 90% of seabirds could contain plastic debris (Mathieu-Denoncourt et al., 2014; Nomadic, Global, 2016).

Alexander H. Tullo (2018) in his paper cites that Britta Denise Hardesty, a principal research scientist with Australia's Commonwealth Scientific & Industrial Research Organisation, who has explored ocean plastics across various regions to have indicated that "You don't see a single coastal site where you don't find trash," and that plastics are being ingested significantly by birds. He cites Hardesty's assessment in which 24% of seabirds amongst 378 dissected had been found to contain debris in their digestive tracts. It has been indicated that Hardesty helped compile a survey of published data suggesting that, by 2050, 95% of all seabirds will be ingesting plastic if the pollution isn't mitigated.

Tullo (2018) further highlights that Chelsea Rochman, who as Assistant Professor in the department of ecology and evolutionary biology at the University of Toronto, found similarly alarming trends in fish. It has been indicated that She led a 2015 study in which researchers bought fish at markets in Indonesia and California and dissected them to see if they could find microplastics—less-than-5-mm fragments that result when the environment shreds littered plastics over time. It is indicated that She found microplastics in 28% of the 76 fish from Indonesia and that She also found debris in 25% of the 64 fish procured in California.

Elin Andersson (2014) in their paper / article highlight the indications from various studies that atleast 180 marine animal species and birds have been found to ingest plastic (citing Teuten et al. 2009). It is also highlighted among fish there are several different studies showing a 35% prevalence of micro plastics (citing Lusher et al. 2013).

Elin Andersson (2014) further cite Andrady et al. (2011) who had concluded that the potentially toxic effects from ingestion of micro plastics was due to either 1) the stress of micro plastic ingestion itself, 2) leakage from the plastics (i.e additives), 3) pollutants associated with the plastic (i.e POPs and heavy metals), or 4) toxic products from the plastics when burnt etc.

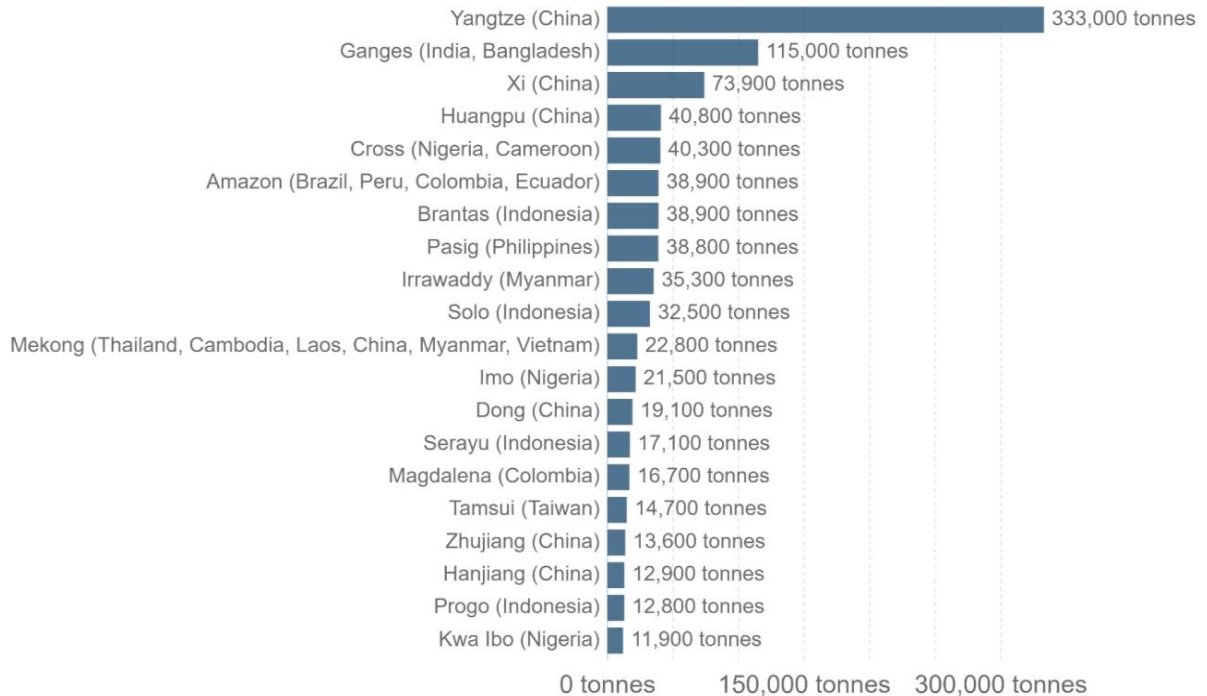
It is also indicated that in various regions there have been significant efforts to reduce the prominence of free range plastic pollution, through reducing plastic consumption, litter cleanup, and promoting plastic recycling and this is a practice growing across various countries (Walker Tony et al. 2018; unenvironment.org ). Some researchers suggest that by 2050 there could be more plastic than fish in the oceans by weight (Sutter John, 2016).

The estimates made also indicate that while every year, more than eight million tons of plastic ends up in the ocean, costing at least \$8 billion (7.1 billion euros) in damage to marine ecosystems, these kill an estimated one million sea birds, 100,000 sea mammals and untold numbers of fish (Ref. News, Rivers Of India, AFP, September 22, 2017 7:42 PM).

Much of the plastics waste act as pollutants and are categorized into micro-, meso-, or macro debris, based on size (Hammer et al., 2012). Since plastics are economical and durable, levels of plastic production is high (Hester et al., 2011). As the chemical structure of most plastics renders them resistant to many natural processes of degradation they are slow to degrade (Le Guem et al., 2018). These two key factors together have led to a high prominence of plastic pollution in the environment.

The assessments regarding inputs of plastics to the marine environment via the riverine pathway has been a parallelly focused area of research and analysis. There has been an assessment of the input of plastics being conveyed by rivers to the oceans and **Figure 11.2** highlights the quantum of plastics 20 rivers across different countries have contributed to plastic pollution in oceans.





**Figure 11.2: Estimated Input of Plastic to the Oceans from top 20 Rivers**

According to the above estimates Yangtze River (China) and Ganga River (India) have been the first two in the list at 0.333 Million Tonnes and 0.115 Million Tonnes of plastics inputs into the oceans respectively.

## 12 The distinction between macro - and micro – plastics and macro - and micro - debris

It has been emphasised that plastics can be encountered in two forms: large plastic wastes called macroplastics, which usually enter the marine environment in their manufactured sizes or in abraded forms, and small plastic particulates below 5 mm in size called microplastics. Microplastics are said to be of two types:

- Primary microplastics are directly released into the environment in the form of small particles. They can be a voluntary addition to products such as scrubbing agents in toiletries and cosmetics (e.g. shower gels). Additional examples of these would be bottle caps, cigarette butts, and microbeads etc. (Pettipas Shauna et al., 2016).

- Secondary microplastics originate from the degradation of larger plastic items into smaller plastic fragments once exposed to the marine environment (Driedger, Alexander G.J. et al., 2015).. This happens through photodegradation and other weathering processes of mismanaged waste such as discarded plastic bags or from unintentional losses such as fishing nets

Another way the differentiation is put across is the application of the term plastic debris and of the indications that there are three major forms of plastic that contribute to plastic pollution, which include microplastics as well as mega- and macro-plastics as making up plastic debris ([https://en.wikipedia.org/wiki/Plastic\\_pollution](https://en.wikipedia.org/wiki/Plastic_pollution) accessed 20 March 2020). It has been indicated and found that mega- and micro plastics have accumulated in high densities in the Northern Hemisphere, and concentrated around urban centers and water fronts. In addition it has been noted that plastic can be found off the coast of some islands because of currents carrying the debris. On the one hand are found mega- and macro-plastics that are being used to make packaging, footwear, and other domestic items that have been washed off of ships (for example) or discarded in landfills and dumpsites and becoming hotspots being assessed, and on the other are microplastics either as degraded and weathered out macroplastics, or as microbeads and others manufactured and reaching via various products and routes into the marine environment.

Additional studies have found that fishing-related items are more likely to be found around remote islands (Walker T.R. et al., 1997; Barnes D.K.A. et al, 2009). These may also be referred to as micro-, meso-, and macro debris.

Microdebris are plastic pieces between 2 mm and 5 mm in size (Barnes D.K.A., et al., 2009). Plastic debris that starts off as meso- or macrodebris can become microdebris through degradation and collisions that break it down into smaller pieces. Microdebris is also being referred to as nurdles (Hammer J. Kraak et al., 2012). It has been indicated that Nurdles are recycled to make new plastic items, but they easily end up released into the environment during production because of their small size and that they often end up in ocean waters through rivers and streams (Hammer J. Kraak et al., 2012). Microdebris that come from cleaning and cosmetic products are also referred to as scrubbers. Because microdebris and scrubbers are so small in size, filter-feeding organisms often consume them

(Hammer J. Kraak et al., 2012). It is estimated that 10% of the plastics in the ocean are nurdles, making them one of the most common types of plastic pollution, along with plastic bags and food containers (Knight 2012). It is indicated that these micro-plastics can accumulate in the oceans and allow for the accumulation of Persistent Bio-accumulating Toxins such as bisphenol A, polystyrene, DDT, and PCB's which are hydrophobic in nature and can cause adverse health affects ( Knight, 2012).

It has been cited that a 2004 study by Richard Thompson from the University of Plymouth, UK, found a great amount of microdebris on the beaches and waters in Europe, the Americas, Australia, Africa, and Antarctica (Le Guern, Claire, March 2018). The indication has been that Thompson and his associates found that plastic pellets from both domestic and industrial sources were being broken down into much smaller plastic pieces, some having a diameter smaller than human hair and that if not ingested, this microdebris floats instead of being absorbed into the marine environment. Thompson predicted there may be 300,000 plastic items per squarekilometre of sea surface and 100,000 plastic particles per square kilometre of seabed (Le Guern, Claire, March 2018). Further, International pellet watch collected samples of polythene pellets from 30 beaches from 17 countries which were then analysed for organic micro-pollutants. It was found that pellets found on beaches in America, Vietnam and southern Africa contained compounds from pesticides suggesting a high use of pesticides in the areas (Otaga, Y. (2009).

Further, plastic debris is categorized as macrodebris when it is larger than 20 mm. These include items such as plastic grocery bags (Hammer J. Kraak et al., 2012). It is also informed that macrodebris are often found in ocean waters, and can have a serious impact on the native organisms and that fishing nets have been prime pollutants. It is indicated that even after they have been abandoned, they continue to trap marine organisms and other plastic debris.

The perspectives and insights from literature as well as project activities concerning macroplastics and microplastics assessments in a set of hotspots in selected cities along with related thematic literature have been presented in chapters focused on these themes.

### 13 Plastic Pollution & Its Impacts

The widespread consumption of plastics due to their industrial and domestic applications since 1950 has resulted in significant benefits to society. Major benefits include medical application (health benefits), less wastage (improved packaging) and improved energy and water efficiency (resource efficiency). The lower costs of plastic products due to un-internalized environmental and societal costs and their diverse applications make it an attractive commodity for consumption. However, a number of negative impacts have been identified both on account of plastic production and consumption. **This section describes these impacts in general and what could be the expected impacts in the context of Ganga basin.**

### 14 Impacts on Terrestrial Ecosystem

The impact of plastic pollution on terrestrial ecosystem includes impact on air, land, soil, water and vegetation which are the integral components of terrestrial ecosystem. De Souza Machado et al., 2018 has reported diverse sources of plastic pollution including domestic sewage, containing fibers from clothing and microplastic beads from personal care products. Other sources include biosolids (Carr et al., 2016; Mason et al., 2016; McCormick et al., 2016; Talvitie et al., 2017; Ziajahromi et al., 2017), fertilizers (Nizzetto et al., 2016a; Horton et al., 2017), landfills from urban and industrial centers (Nizzetto et al., 2016b), irrigation with wastewater, lake water flooding, littering roads and illegal waste dumping (Bl€asing and Amelung, 2018), vinyl mulch used in agricultural activities (Kasirajan and Ngouajio, 2012; Li et al., 2014b; Farmer et al., 2017; Sintim and Flury, 2017) and tire abrasion (Dubai and Liebezeit, 2013; Foitzik et al., 2018; Wagner et al., 2018) .

#### Impact on Air

The contribution of the atmospheric fallout as a potential vector of plastic pollution has been reported in literature (Dris et. Al., 2016). It indicates that air quality monitoring results in both urban and rural environment contain significant amount (29%) of fibers in atmospheric fallout. These microplastics have different possible sources such as synthetic fibers from clothes and houses, degradation of macroplastics, and landfills or waste incineration. Free et al., 2014 reported that these fibers in the atmosphere, including microplastics, could be transported by wind to the aquatic environment or deposited on surfaces of cities or agro

systems. After deposition, they could impact terrestrial organisms or be transported into the aquatic systems through the runoff.

### **Impact on Soil**

Different types of plastics enter the soil environment, settle on the surface, and penetrate into sub soils. Rillig, 2012;Liu et al., 2014; Nizzetto et al., 2016a,2016b have also pointed out the potential effects of widespread plastic contamination in the soil environment, emphasizing on the adverse effects of plastics andMPs in soils. Liu et al., 2014;Rochman et al., 2015;Nizzetto et al., 2016a have reported plastic wastes in the soil media and warned about the dangers of small plastics in the soil and terrestrial ecosystems. Studies have reported that the synthetic fibers can be transferred to the soil and can pollute soil environments via the application of the effluent to land. Huerta Lwanga et al., 2016 have concluded their activities such as ingestion of soils and excretion of casts may be the main mechanism behind the transport of micro plastics in the soil ecosystem. PE is one of the most common plastics found in soil because of landfill with sewage sludge containing primary micro plastics from personal care products (McCormick et al., 2016; Talvitie et al., 2017) and PE vinyl mulch from agricultural activities (Kasirajan and Ngouajio, 2012<sup>1</sup>; Li et al., 2014b; Sintim and Flury, 2017). Gaylor et al. (2013) simulated the exposure of polybrominated diphenyl ether (PBDE) to earthworm *Eisenia fetida*with various exposure scenarios (biosolid or polyurethane foam microparticles that contain PBDEs). They found that PBDEs leached from polyurethane foam (<75 mm) were accumulated in the bodies of earthworms. Therefore, chemicals derived from micro plastics can enter the soil ecosystem and be accumulated in soil invertebrate organisms. Additives or hazardous chemicals in micro plastics such as PBDEs can be transferred to other environments and organisms (Chen et al., 2013; Hong et al., 2017) in the soil ecosystem. Rodriguez- Seijo et al. (2017) confirmed that these increases of nutrients are caused by multiple stress-response mechanisms of the immune system of *E. andreito* micro plastic exposure. **These results indicate that micro plastics can impact non-target species in soil biota.**

### **Impact on Ground Water**

Several researchers have warned off the potential distribution and transportation of micro plastics into groundwater and the hyporheic zone based on previous studies about their transportation. Rillig et al. (2017)commented that microplastics can migrate through the soil profile and reach the groundwater.

Bl€asing and Amelung (2018) also warned of the potential of nanoplastics or colloids to pass through macropores and coarse soil. Scheurer and Bigalke (2018) suggested the probability of microplastics to be transferred to groundwater in areas with high groundwater table and coarse soils. Bottom ash produced from burned plastics in open dumps also contaminates the soil and water resources.

### **Impact on Terrestrial Food Chain**

Huerta Lwanga et al. (2017b) investigated the concentrations of micro plastics in home garden soil, earthworm casts, and chicken (*Gallus gallus domesticus*) feces. The concentrations increased along the trophic levels and the highest concentration of micro plastics was confirmed in chicken feces ( $129.8 \pm 82.3$  particles  $g_{-1}$ ). In particular, chicken gizzards (food) also contained micro plastics ( $10.2 \pm 13.8$  micro plastics per gizzard), and this suggested the evidence of transfer of micro plastics to humans through food.

It can be summarized that impacts on terrestrial ecosystem include: (i) micro plastics may have adverse effects on and can be accumulated in soil organisms, ii) additives derived from micro plastics can be accumulated in soil organisms, iii) micro plastics can cause changes in the chemical contents of soil organisms, iv) responses of soil organisms exposed to micro plastics can cause changes in soil characteristics, v) chemicals adsorbed on micro plastics can enter the soil ecosystem, vi) micro plastics can move horizontally and vertically, (vii) plastic and micro plastics impact atmosphere and (viii) plastics and micro plastics can impact ground water.

### **Impacts on Aquatic and Marine Ecosystem**

Law and Thompson,(2014) Horton et al., (2017) reported that riverine transport of plastic debris accounts for 80% of the release from land to the marine environment. Lebreton et al., (2017) indicated that the river is one of the main sources of plastic pollution carrying 2 million tones of microplastics per year in the marine environment. Plastic transport through river has been reported in various rivers worldwide viz. Los Angeles River (Moore et al., 2005), Danube (Lechner et al., 2014), Yangtze Estuary (Zhao et al.,2014), Rhine (Mani et al., 2015), Selenga River (Battulga et al., 2019),Beijiang River (Tan et al., 2019), Ciwalengke River (Alam et al., 2019). The occurrence and consequences of macro plastic debris in coastal and marine environments have been reported during the 1970s. Carpenter and Smith 1972, Derraik 2002,Barnes et al. 2009,

Ivar do Sul and Costa 2013 have reported that plastics degrade and fragment into smaller pieces in marine environment and pose a substantial threat to marine biota.

Broadly marine wildlife is impacted by plastic pollution through entanglement, ingestion, bioaccumulation, and changes to the integrity and functioning of habitats. While macroplastic debris is the main contributor to entanglement, both micro and macrodebris are ingested across a wide range of marine species. Lusher et al. 2017 reported concern of the potential harm caused by the ingestion of microplastics by marine organisms, both to the organism and potentially to human consumers of seafood. Microplastics can cause direct physical damage or indirect damage through an inflammatory response to an ingested particle. Alternatively, there may be a satiation effect where the organism feels full, but the 'food' lacks nutrition and cannot be readily digested. In addition, there is the potential for harm due to the leaching of chemicals from within the polymer. Further, they may act as vectors for the transfer of chemical contaminants through the food chain.

The impacts due to the physical and chemical characteristic of plastics to marine wildlife are now well established for many taxa, including mammals (Laist 1987, 1997, Page et al. 2004), seabirds (Laist 1997, van Franeker et al. 2011), sea turtles (Beck and Barros 1991, Tomás et al. 2002, Wabnitz and Nichols 2010, Guebert Bartholo et al. 2011, Lazar and Gra an 2011, Schuyler et al. 2014), fish (Boerger et al. 2010, Possatto et al. 2011, Ramos et al. 2012, Dantas et al. 2013, Choy and Drazen 2013), and a range of invertebrates (Chiappone et al. 2005). Müller et al. 2012 has reported that over 170 marine species have been recorded to ingest human-made polymers that could cause life-threatening complications such as gut impaction and perforation, reduced food intake, and transfer of toxic compounds.

### **Impacts of Plastic Pollution on Food chain / Trophic linkages**

Studies conducted by Wright et al. (2013), indicated that microplastics are ingested at every level of the marine food web, from filter-feeding marine invertebrates, to fishes, seabirds, sea turtles, and marine mammals. Thompson et al. (2004) and Browne et al. (2011) reported presence of plankton and plastic particles <333 µm and (<100 µm) diameter polymer fibers in marine system and in sediments, suggesting that plastics exposure is occurring at the base of the food web. Wegner et al. (2012) and Besseling et al. (2013) have identified impacts to marine invertebrates are associated with foraging on nano- and micro

particles of polystyrene. De Mott (1988), Bern (1990) and Cole et al. (2013) has demonstrated and examined plastic ingestion by zooplankton at laboratory scale. Farrell and Nelson (2013) has reported recent evidence that ingested micro plastics can bridge trophic levels into crustaceans and other secondary consumers. Lavers et al. (2013), (2014) and Tanaka et al. (2013) have detected plastic-derived compounds in the tissues of seabirds that had consumed plastics.

### **Impacts of Wildlife Entanglement**

Shomura and Yoshida 1985, Gilardi et al. (2010), [Allen et al. (2012) have indicated marine debris entanglement as an internationally recognized threat to marine taxa. Laist (1997), Udyawer et al. (2013) have reported that at least 135 species are ensnared in marine debris, including sea snakes, turtles, seabirds, pinnipeds, cetaceans, and sirenians. Wildlife gets entangled in everything such as monofilament line and rope to packing straps, hair bands, discarded hats, and lines from crab pots. Wegner and Cartamil (2012) has reported the presence of the entanglement effects include abrasions, lesions, constriction, scoliosis, Feldkamp (1985) and Feldkamp et al. (1989) have reported loss of limbs, as well as increased drag, which may result in decreased foraging efficiency and (Gregory 1991, 2009) reduced ability to avoid predators. Henderson (2001), Boland and Donohue (2003), Karamanlidis et al. (2008) have reported that entanglement is a key factor threatening survival and persistence of some species, including the northern fur seal *Callorhinus ursinus* Fowler (1987) and Votier et al. (2011) and endangered species such as Hawaiian and Mediterranean monk seals (*Monachus* spp.). Henderson (2001) has reported that among marine mammals there are important age-class drivers of entanglement rates; for example, in pinnipeds, younger animals (e.g. seal pups and juveniles) may be more likely to become entangled in nets, whereas subadults and adults are more likely to become entangled in line. Fowler (1987), Hanni and Pyle (2000), Henderson (2001) has reported that in general, younger, immature animals are more often reported as entangled, at least in pinniped studies for which age class is reported. Poon (2005), Gunn et al. (2010) and Wilcox et al. (2013) have also reported that ghost nets also ensnare cetaceans, turtles, sharks, crocodiles, crabs, lobsters, and numerous other species.

## **15 The issue of mismanaged plastic waste**

Mismanaged waste is commonly defined as plastic waste managed in a way that might include some leakage into the marine environment. This includes waste entering non-sanitary landfills, dumpsites, or

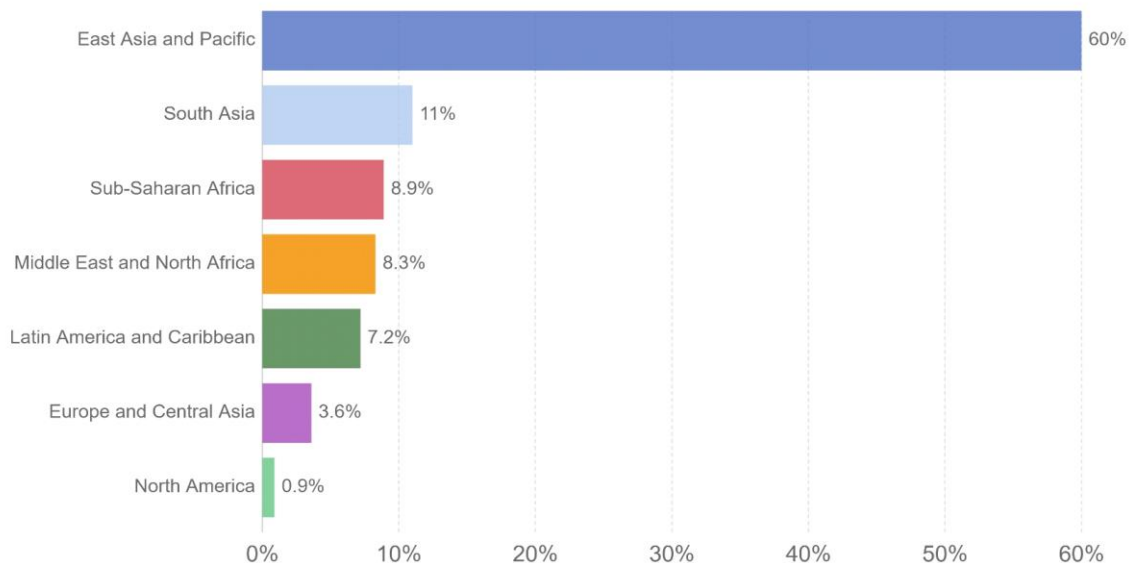


tipped/littered. The percentage wise geographical contributions towards global mismanaged plastic waste is presented in Figure 15.1. The focus is on mismanaged waste by populations (either littered or inadequately disposed) within 50 km of coastlines and which have high risk of entering the oceans. It is highlighted here that East Asia and Pacific contributed to almost 60% of the global mismanaged plastic, while North America and Europe and Central Asia added together contributed in the range of 4.5% (Source : OWID – Our World in Data based on Jambeck et al., 2015).

### Global mismanaged plastic by region, 2010



This is measured as the total mismanaged waste by populations within 50km of the coastline, and therefore defined as high risk of entering the oceans. Mismanaged plastic waste is defined as "plastic that is either littered or inadequately disposed. Inadequately disposed waste is not formally managed and includes disposal in dumps or open, uncontrolled landfills, where it is not fully contained. Mismanaged waste could eventually enter the ocean via inland waterways, wastewater outflows, and transport by wind or tides."



Source: OWID based on Jambeck et al. (2015)  
OurWorldInData.org/plastic-pollution • CC BY

**Figure 15.1 : Regional contributions towards mismanaged plastic wastes as of year 2010**

A global map reflecting the categorised and colour shaded quantity aspects, as a representative perspective, has been also prepared, which is presented in **Figure 15.2** to reflect on the likely range of mismanaged plastic waste (in Millions of Metric Tonnes) by populations in those regions living within 50 km of the coasts.

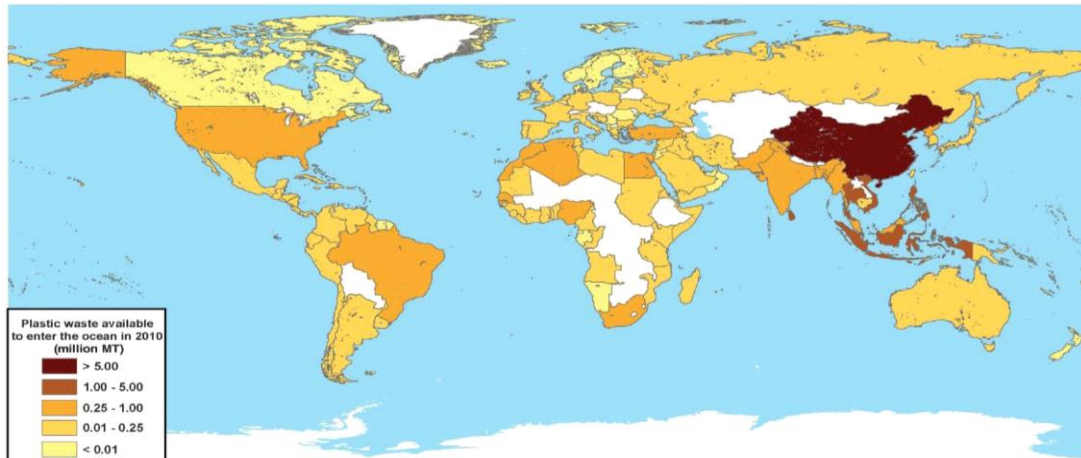


Fig. 1. Global map with each country shaded according to the estimated mass of mismanaged plastic waste [millions of metric tons (MT)] generated in 2010 by populations living within 50 km of the coast. We considered 192 countries. Countries not included in the study are shaded white.

**Figure 15.2: World map of estimated mass of mismanaged plastic wastes as of year 2010**

## 16 The main sources of plastic waste leakages – A perspective

The section below describes leakage from four main sources, estimating the quantities flowing into the marine environment as reported in the literature:

### (i) Coastal Mismanaged Plastic Waste (MPW): 8 Mt/y

The most commonly cited orders of magnitude were published by Jambeck et al. in 2015. This research focused on the amount of mismanaged plastic waste likely to be generated by the coastal population of 192 countries living in a 50 km fringe from the shores. The calculations were based on the mass of waste generated per capita annually, the percentage of plastic materials in the waste and the percentage of mismanaged plastic waste likely to enter the oceans as debris (which includes the share of inadequately managed waste per country and a default global littering rate of 2%).

This study and research reached a conclusion that annual leakages of MPW into the marine environment ranged from 4.8 to 12.7 Mt/y (Million Tonnes per Year). There have been additional estimates wherein the indications have been from from 3.87 Mt/y (UN Environment, 2018) to 9 Mt/y (EUNOMIA, 2016) on their global plastic leakage estimate of 8.28 Mt/y and 12.2 Mt/y respectively.

### (ii) Inland MPW: 2 Mt/y

Contributions of rivers to the marine plastic pollution via leakage scenarios has been indicated to be fluctuating and depended on seasonality and geographical location. Globally, rivers would be responsible for plastic waste inputs ranging from 1.15 Mt/y to 2.41 Mt/y, with 67% of these emissions originating from Asia alone (Lebreton et al. 2017). This study and estimates has been considered to be reflecting a good correlation between population densities, waste management data and results from observational river studies and measurements. In addition, another study estimated riverine inputs as ranging between 0.41 Mt/y and 4 Mt/y (Schmidt, Krauth and Wagner, 2017). Discrepancies between the two studies are due to different parameters used, such as the number of coastal countries considered.

### **(iii) Lost fishing gear: 0.6 Mt/y**

It is indicated by Boucher and Friot (2017) that the fishing and aquaculture sectors emit large quantities of litter (such as derelict gear), including 0.6 Mt of microplastics per year for the fishing industry. The field studies have reported a prevalence of blue fibres (nylon) specific to fishing devices. Other orders of magnitude have been published, with, for example, a loss rate of derelict fishing gear of 1.15 Mt/y (EUNOMIA, 2016). It is informed that the sources here are very scarce and the precision desired may be difficult to arrive at due to unreliability factors. Further, litter from ships that is thrown overboard, and which is supposedly prohibited, also contributes to overall plastic pollution and this has been estimated to be in the range of 600 kt/y (EUNOMIA, 2016).

### **(iv) Primary microplastics: 1.5 Mt/y**

The study concerning estimation of primary microplastics entering the marine environment has arrived at a value of about 1.5 Mt/y of primary plastics reaching the oceans. There are other estimates as well, for example:

It is estimated as per UN Environment (2018) that about 3.01 Mt is primary plastics on a total plastic loss of 8.28 Mt/y. As per EUNOMIA (2016) about 0.95 Mt has been primary plastics in a total loss of 12.2 Mt/y.

In percentage share, these estimates equate to approximately 15%, 36%, and 8% of global plastic leakage (UN Environment, 2018; Boucher and Friot,

2017; EUNOMIA, 2016). There are estimates regarding leakages due to tyre abrasion and these are equated to 1,400 / 420 / 270 kt/y (UN Environment, 2018; Boucher and Friot, 2017; EUNOMIA, 2016). Further is estimates on Road marking leakages as 590 / 105 / 80 kt/y respectively, and washed out microfibres estimated at 260 / 525/190 kt/y according to the same sources.

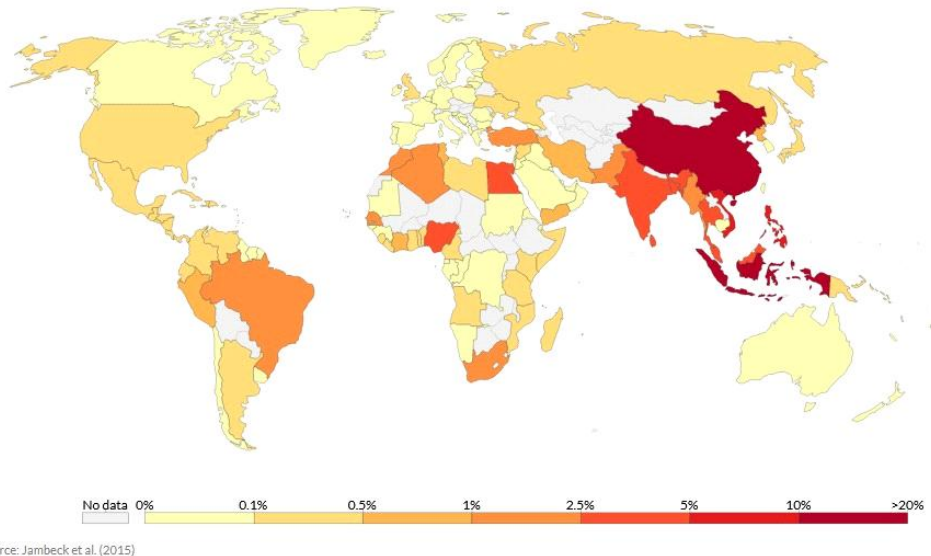
It is emphasized that these estimates are a subject of debate, yet there is a consensus on the fact that they are mainly caused by the leakage, dependent on regional conditions and archetypes. Leakage of macroplastics from mismanaged waste is dominant in coastal countries, especially those with less adapted waste management facilities (Boucher and Friot, 2017).

### Projected Mismanaged Plastic Waste in 2025

The studies on mismanaged plastic wastes have led to making projections for likely mismanaged wastes in the future as well. Figure 16.1 presents a global map of projected share of mismanaged plastic waste by 2025.

#### Projected share of global mismanaged plastic waste in 2025

Projected share of global mismanaged waste produced in 2025. This is measured as the total mismanaged waste by populations within 50km of the coastline, and therefore defined as high risk of entering the oceans. Mismanaged plastic waste is defined as "plastic that is either littered or inadequately disposed. Inadequately disposed waste is not formally managed and includes disposal in dumps or open, uncontrolled landfills, where it is not fully contained. Mismanaged waste could eventually enter the ocean via inland waterways, wastewater outflows, and transport by wind or tides."



**Figure 16.1 A map of projected share of mismanaged plastic waste in 2025 in a geographical context**

It is however important to note that many uncertainties prevail in forecasting of plastic pollution at global level. Uncertainties can either be structural (understanding of the mechanisms and pathways of the leakage) or data related (availability of reliable datasets, which are particularly difficult to obtain in certain countries).

## **17 Challenges of measuring of plastic pollution**

The need for achieving efficient forecasting of plastic waste pollution levels requires some level of validation from field studies. It has been noted that the comparison between modelling and field approaches is leading to variations and questionable results. For instance, on the one hand it is estimated that between 250,000 to 300,000 kt of plastic debris is floating in the World Ocean (Eriksen et al. 2014; van Sebille et al. 2015), which is found to be almost two orders of magnitude below the predictions of annual inputs based on modelled results of about 4-12 Mt (Jambeck et al. 2015). Further, there is an ongoing debate in the scientific community regarding the spatial distribution and fate of plastics in the water column in the oceans. There is lack of clarity as to whether plastics sink and further accumulate in the deep-sea (which does not get measured by surface sampling as per Woodall et al. 2014 and Koelmans et al. 2017) and/or whether it is being accumulated in the food web / food chains or whether it is oscillating in the water column (Kooi et al. 2017).

In addition to the above indicated aspect, there is a need to reflect on whether contemporary sampling methods are adequately suitable for the detection of very small particles, considering correction models are being rarely implemented.

- The indications by Kukulka et al. 2012 has been that studies focusing on surface quantification are not applying correction models when sampling in windy conditions and accordingly, concentrations of plastics being measured can be largely underestimated due to wind and wave events. It is emphasized that this is a major drawback in plastic pollution assessments, as it has been shown that plastic (mainly micro-mesoplastic) concentrations could be 2.5 times higher when wind correction models are applied in > 8 knots conditions (Kukulka et al. 2012).

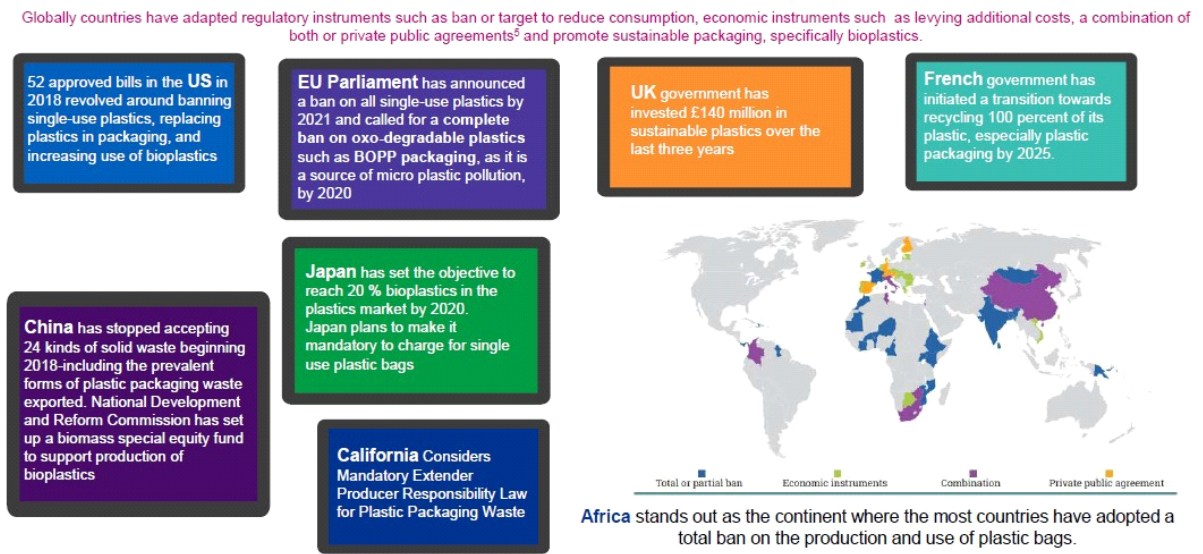
- Another feature that is evident from the studies is that when sampling surface debris, there has been a tendency to provide metric results in average particles by surface area (as items per sq.km) and a sum total of particles counted. In parallel however, the weight of debris is rarely provided as additional information which is of significant value for enabling the assessments at a grainier level.
- There has been a consistent observation and emphasis that there is a need for standardization of sampling methodologies (GESAMP , 2014). It has been noted that sampling methodologies (towing time and speed, net dimensions and mesh sizes) significantly fluctuate between studies, influencing the catchability of plastics. Whitacre (2012) inform that there is a lack of a standardised approach for sampling plastic at sea, and due to an inconsistent reporting scheme, datasets are rarely comparable.
- There have been assessments that microplastic abundance tends to differ with depth in the water column. This mainly concerns very small debris (10µm or 0.01 mm) that present different sinking rates compared to larger microplastics (Enders et al. 2015). Further, it is indicated that the abundance of larger debris (e.g. 1 mm) decreases with depth, and therefore concentrates mainly in the surface layer. Smaller debris (10 µm) show a relatively constant and high abundance from 0 to 100 m depth. Additionally, another study discovered that the abundance of < 300 µm debris increased with depth, with artificial fibres accounting for the main plastic type in the water column (Dai et al. 2018).
- Further is the assessment that there are uncertainties regarding settling rates of microplastics from the surface to the seafloor with two main factors influencing this process as biofouling and water stratification.
- *Biofouling*: is defined as “the accumulation of organisms on submerged surfaces affecting the hydrophobicity and buoyancy of plastic” (Kooi et al. 2017). Once loaded with organic matter, particles start to oscillate in the water column in different ways, depending on the photosynthesis rate (Kooi et al. 2017).

- *Water stratification and circulation:* water bodies of different densities occur in some oceans and seas such as the Mediterranean. For example, surface and deep-water masses display independent circulation patterns but up to now, the influence of this circulation on plastic transfer toward the deep sea has not been documented (El-Geziry and Bryden, 2010).

Further, it is to be noted that analysis of plastic samples relies upon very manual procedures, which slows the processes and thus reduces the extent and quantum of sampling being achieved. It is conjectured that developing more automated measurement protocols, for example based on machine learning, would enable considerable progress in this field. Further, suitable tracing of specific particles, such as tyre dust would be required and desirable to validate orders of magnitude provided by top-down modeling approach.

## 18 International efforts to check plastic waste generation

The efforts to address plastics pollution and especially regulatory measures in a few regions and countries including focus on single use plastics have emerged and taken the form of bans on single use plastics, encouraging targeted use of bioplastics, checks on import of plastic waste that was earlier used for recycling or conversion to fuel related applications, investments towards developing sustainable plastics and for recycling efforts. A perspective overview of this is presented in Figure 18.1.



## **Figure 18.1: International regulatory developments concerning plastics and packaging**

*(Source : KPMG presentation, 2019)*

It has also been reflected in literature that

- Globally, around 95% of plastic packaging material value is lost after a short first-use cycle. This is equivalent to a lost value of approx. USD 80 - 120 billion.
- The total social and environmental cost of plastic pollution is estimated to be USD 139 Billion per year !!

A review had been undertaken by UNEP on the international framework on the instruments being developed for tackling plastic waste management which included exploring whether these were designed to be binding or voluntary for participating countries / regions and also reflecting on gaps in addressing pollution as marine plastic litter and microplastics. It is indicative that various conventions, protocols have been developed and that there have been both binding and voluntary features of these, including a range of gaps to address the marine litter problem.

### **19 Plastics waste generation and management in the Indian context and significance of the study**

India consumed 16.5 million tonnes (MT) of plastic annually – which was expected to increase to 20 MT by 2020. (FICCI, 2017) and the indicated consumption by 2019 – 20 has been in this range as well as indicated in earlier sections. As per Sri Sasi Jyothsna T., Chakradhar B. (2020) India generates around 56 lakh tonnes of plastic waste annually and Delhi being the highest generator of plastic waste in India accounts for 9,600 mt per day among the top ten cities, followed by Chennai, Kolkata, Mumbai, Bangalore etc.

As regards status in 2016-17, 43% of plastics consumption was plastic manufactured for single-use packaging material Further as of 2016 the Central Pollution Control Board of India had estimated that plastic waste generation was about 25,940 TPD (based on a per capita national



multiplier) of which approximately 15,000 TPD was being collected (57.8%) for management including partly for recycling purposes (CPCB, 2017).

There has also been a collation of information / data from 60 cities that there was about 4059 Tonnes Per day of Plastic waste generation in these 60 cities put together as per CPCB Report: LATS/21/2015-16. The information collated indicated that Plastic waste generation in Delhi was at the time about 689 TPD. And the estimates in India had also been made that 94% of plastic waste being generated in India was recyclable (CPCB Report: LATS/21/2015-16).

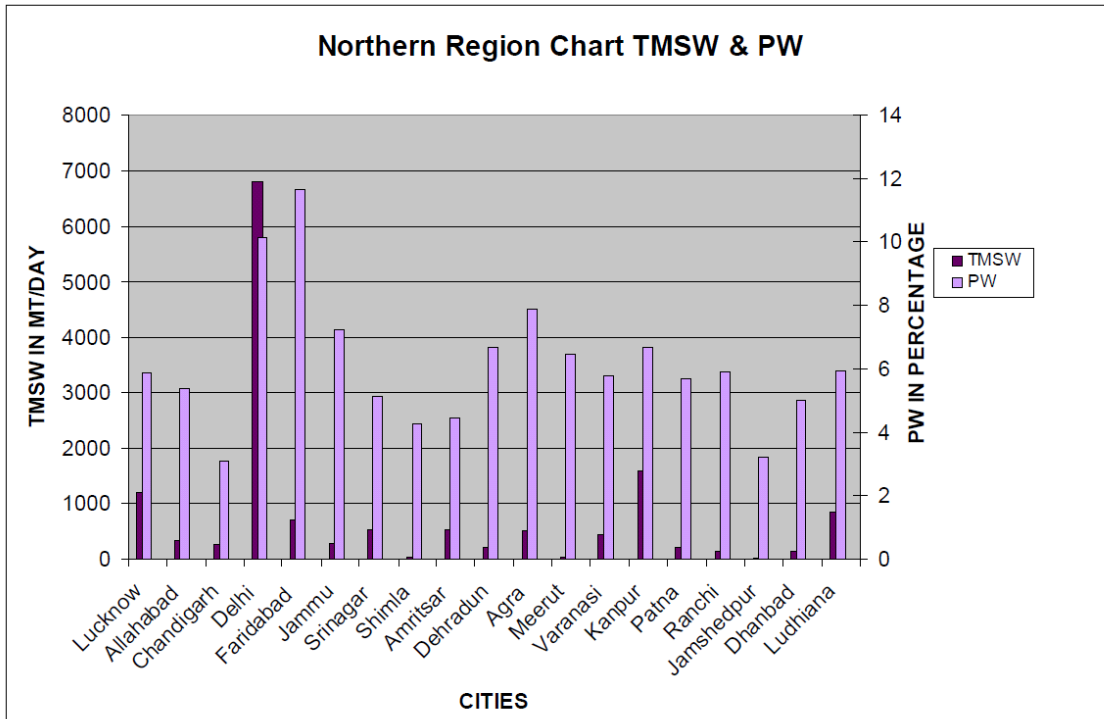
The estimates for India reflected upon the Plastic waste content in Municipal Solid Wastes as well which was being found to be in the range of 3.10% (Chandigarh) & 12.47% (Surat) in the urban landscape assessed. The national average was further indicated to be 6.92% of Plastic waste content in Municipal Solid Wastes in India.

Further, efforts to estimate and to control Plastic Waste and improve the management aspects led to the development and notification of Plastic Waste Management Rules, 2016 and its amendments thereafter in 2018 / 19 and the additional features of Plastic Waste in India is reflected below.

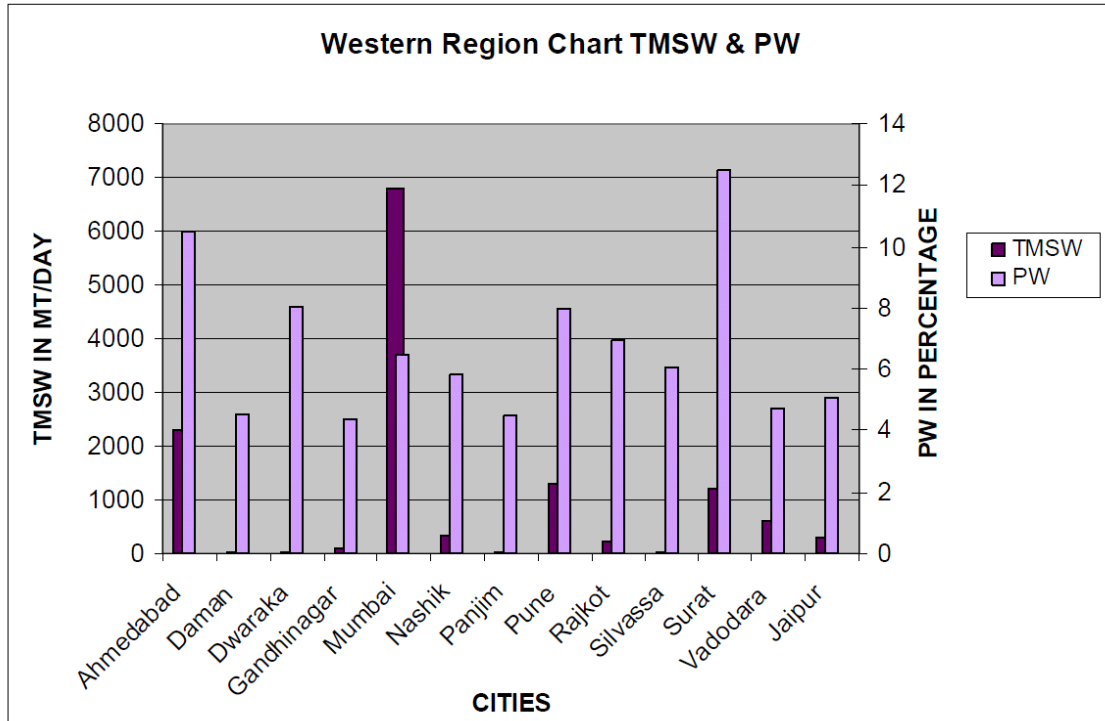
Plastic Waste Management Rules notified in 2016 (Gazette of India from CPCB, 2016), further amended in 2018 highlighted that 25 states had banned the use of plastic carry bags, and that there was slow implementation of provisions for Extended Producer Responsibility (EPR). There was also an indication that there were gaps of information from states in submitting data pertaining to plastic waste generation and its management. There were reflections that Imports of plastic waste was around 48,000 Tonnes during 2017 - 18 for various purposes, which however by March, 2019 was banned as per amendments in the PWM Rules (IndiaSpend, 2019).

In context of regions the indicative studies / assessments carried out for determining total municipal solid waste and plastic waste generation have presented some insights as well regarding a set of cities (Figure 19.1 a and b). For example in the northern region, amongst a set of cities where assessments have been made, Faridabad has presented over 11% of plastics waste in the Municipal Solid Waste generated in the city and Delhi is in the range of 10%, and Agra about 8%. Further, in the western region

the following chart highlights the features. In the western sector from the selected cities Surat has over 12% of the Municipal Waste as Plastic Waste generated and Mumbai about 6.5%.

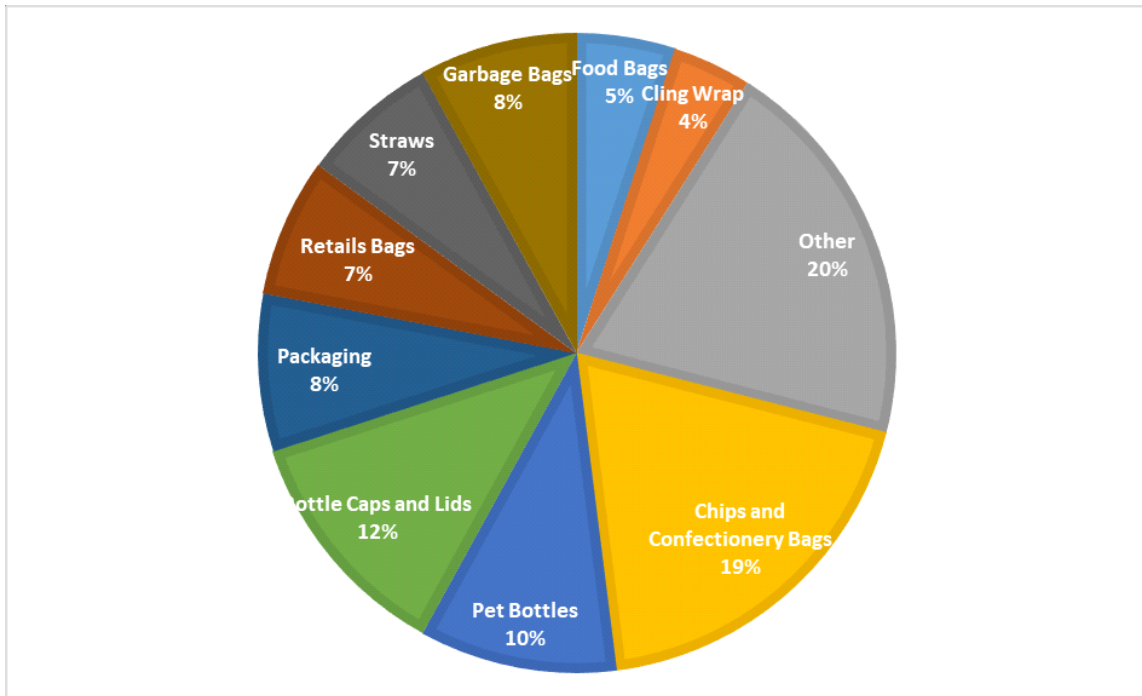


**Figure 19.1 a: Plastic Waste generation levels vis a vis Total Municipal Solid Waste Generation in selected cities in Northern India**



**Figure 19.1 b: Plastic Waste generation levels vis a vis Total Municipal Solid Waste Generation in selected cities in Western India**

Plastics as part of packaging wastes have also been assessed for their recycling rates in India and further compared with a few countries / regions and that the composition of plastics packaging waste in general has also been indicated by studies conducted by CIPET as reflected in **Figures 19.2** and **Figures 19.3** and **Table 19.1**.



**Figure 19.2 : Plastics packaging wastes in India (Mohanty, CIPET Presentation)**

Table 19.1 Plastics recycling rates in India (Mohanty, CIPET Presentation)

Packaging Waste	Recycling Rates
Plastics Recycling rate	60%
PET Recycling rate	90%
PET Composition	10%
Non PET recycling rate	55-60%

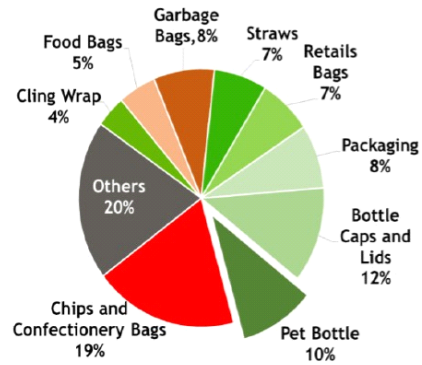
# PACKAGING WASTE CONSTITUTES THE MAJOR PART OF PLASTIC WASTE IN INDIA



- Plastics Recycling rate - 60%
- PET recycling rate - 90%
- PET Composition - 10%
- Non PET recycling rate - 55-60%

**Solutions required for :**

- Chips and Confectionery bags- Multilayer
- Garbage Bag
- Food Bag
- One time use sachets
- Sanitary Waste/Diapers



Source : Plastic Packaging – the sustainable and smarter choice, FICCI, Strategy& -PwC, 2015

## CURRENT PLASTIC PACKAGING RECYCLING RATE



**Recycling rates**

Countries	Recycling Rates
USA	Overall ~ 25% - 9.5% recycled - 15% energy recovery - 75% landfill
EU 28 + 2	Overall recovery ratio ~ 69 %
China	22%
<b>India</b>	<b>60% (CPCB)</b>

Only 14% of plastics packaging is recycled globally



India fares far better in plastic recycling – THANKS TO THE WASTE PICKER BASED RECYCLING ECONOMY.....

.....Better Recycling rates in India

Figure 19.3: Plastics packaging wastes and recycling rates in India (Mohanty, CIPET Presentation)

The figures are indicative that recycling rates of plastics packaging in India is estimated to be at about 60% of plastics in packaging and that PET bottles and other products are recycled to about 90% levels in India as it has substantive recycling and reuse economic value and has been convenient to recycle and create new products.

There is accordingly, need for further studies to estimate as well as verify these estimates made by various organisations / institutes, especially as the consumption patterns of plastics change over time and new methodologies or data emerges from the field studies.

- **Estimations regarding the India based Plastics Litter and marine pollution contributions and related features**

Plastic waste leaking into the riverine and marine environment have also been estimated from Indian context and these do need further studies for ground truthing and verification through suitably designed studies ahead. A perspective on riverine and marine pollution aspects in the Indian context has been enumerated here.

- India has a coastline of 7,517 kms
- India is currently the 12th largest emitter of marine litter and will become 5<sup>th</sup> largest contributor by 2025 (Jenna Jambeck et al. 2015).
- India is ranked 20 amongst the 192 coastal countries responsible for 83% of land-based plastic waste that ends up in the ocean (Jenna Jambeck et al. 2015).
- River Ganga was the 2nd largest emitter of plastics to the marine environment globally, with a computed input of 0.12 million tonnes of plastics per year (Lebreton, L. C. M. et al. River plastic emissions to the world's oceans, 2017).
- Rivers such as Ganga and Yamuna are severely polluted due to ineffective waste management — 11,625 tonnes of solid waste was being generated every day from cities and towns along these rivers (MoHUA, 2018).

As per a study in four cities / regions in the Gujarat Coast by Sukhdane et al. (2019) the mean abundance of marine litter in Porbandar coast was found as  $95.16 \pm 6.28$  items per sq.m. (with a range from 36–140 items sq.m.) by items and  $24.94 \pm 1.37$  gm per sq.m. (range of 13.99–33.19 gm per sq.m.) by weight. The highest abundance of plastic litter however was recorded in Veraval coast with  $97.66 \pm 6.65$  items per sq.m. (range 66–158 items per sq.m) by items and  $31.59 \pm 1.17$  gm per sq.m (range 19.84–40.18 gm per sq.m. ) by weight. The lowest abundance of number of items per sq.m was recorded in the Madhavpur coast with mean abundance of  $34.88 \pm 2.25$  items per sq.m. (range 19–54 items per sq.m) whereas the lowest weight was

recorded in the Chorwad coast with mean weight of  $13.07 \pm 0.59$  gm per sq.m (8.48–17.30 gm per sq.m). Further, it has been indicated by Sukhdane et al. (2019) that during all the sampling months and all the four different stations, plastic litter was predominated in the marine litter collected ranging from 59.71 to 76.98% of the items collected (with a Mean value of 66.82%). It has been reflected that the abundance of plastics along these beaches especially Porbanadar and Veraval can be attributed with beach visitors, coastal inhabitants and recreational activities that contribute to the major sources of litter pollution on beaches in developing countries due to the littering behavior of the population and high usage of plastics. As part of this study the researchers also estimated that of the aggregate marine litter in the four coastal areas about 78.5% was via land based sources, while remaining about 21.5% was from the sea-based sources.

Another study by Sarkar et al. (2019) carried out to analyse sediments of river Ganga in a set of 7 different cities namely Buxar, Patna, Bhagalpur, Nabadwip, Barrackpore, Godakhali and Fraserganj has presented insights on the nature of meso and microplastics and their distribution that has emerged in these stretches. It has been indicative that all sediments contained mesoplastics (those greater than 5 mm) and microplastics (those less than 5 mm) and the plastic particles were of varying mass fraction such as from 11.48 nanogram of plastics. Further, numerical abundance of plastics in these sediments ranged from 99.27–409.86 items/kg of sediment. The study further led to analysis of mesoplastics via FT-IR equipment and that the major contributor of the plastics was found to be polyethylene terephthalate (@ 39%) as the major contributing plastic debris in the sediments, followed by polyethylene (@ 30%) which has been said to be correlating with the pollution traits. Further, the study highlighted the importance of analysing inland river systems and their role as carriers of plastic fragments towards the oceans.

Another study concerning Macrodebris and microplastics distribution in the beaches of Rameshwaram Coral Island, in Gulf of Mannar in Southeast coast of India has been undertaken by Vidysakar et al (2018). As part of this study marine sediment samples were collected from 20 locations along the coastal areas of the study region and the distribution and characterization of plastics sampled out was carried out by visual examination followed by FTIR spectroscopy. The study found the presence of white-colored and irregular-shaped plastic debris in the locations and amongst the polymers identified here, Polypropylene was dominant besides others identified as polyethylene,

polystyrene, nylon, and polyvinyl chloride. It has been reflected that tourist activities and fishing practices were amongst the key sources of the microplastic debris.

Such studies are indicative of a need for further studies in additional areas including on river beds and river banks and the process led to identifying four cities Haridwar, Agra, Prayagraj and Mumbai for such assessments of macro plastics and littering for both riverine regions and coastal areas of Mumbai.

## **20 Summary of Implications of Plastic Pollution in Ganga Basin**

A perspective on riverine and marine pollution aspects in the context of Ganga basin has been described in this section. The secondary and primary sources of data indicate the level of plastic pollution in Ganga basin consisting majorly of main stem of the river and riparian urban centres.

- Liberton et.al (2017) has estimated that River Ganga was the 2nd largest emitter of plastics to the marine environment globally, with a computed input of 0.12 million tonnes of plastics per year.
- Due to mismanaged solid waste management, about 11,625 tonnes of solid waste was being generated every day from cities and towns along these rivers (MoHUA, 2018).
- Sarkar et al. (2019)[98] analysed sediments (shoreline)of river Ganga in a set of 7 different cities namely Buxar, Patna, Bhagalpur, Nabadwip, Barrackpore, Godakhali and Fraserganj. It indicates that both meso and microplastics, their nature and their distribution in these stretches. It gives insight:
  - All sediments contained mesoplastics (those greater than 5 mm) and microplastics ( those less than 5 mm) and the plastic particles were of varying mass fraction such as from 11.48 nanogram of plastics
  - Numerical abundance of plastics in these sediments ranged from 99.27–409.86 items/kg of sediment.
  - Major contributor of the plastics was found to be polyethylene terephthalate (@ 39%) as the major contributing plastic debris in the sediments, followed by polyethylene (@ 30%)
  - Presence of meso and microplastic showed positive correlation to river water BOD and phosphates.
- Baroth et.al.(2019) presented the findings of the first ever study covering the entire Ganga river (main Stem) as summarized below.
- 72% of the sediment samples from river Ganga were found to contain



- microplastics. Polypropylene was the most abundant polymer type followed by polyethylene and polyvinyl aldehyde.
- Middle zone of river Ganga recorded highest abundance for Microplastics due to larger river flowing through this region and relatively higher input of waste into the river.
  - Results are low in values as compared to the sediments of other rivers of the world such as Beijiang river, China (Wang et al., 2017), rivers from Shanghai (Peng et al., 2018), Atoyac river, Central Mexico (Shruti et al., 2018), river Tame, UK (Tibbetts, 2018) etc.
  - Quality control and cross contamination issues were handled appropriately as per the NOAA guidelines.
  - Analysis for seasonal variation and other matrices for Microplastic contamination is in progress
  - **Data from the macro and micro plastic studies carried out by NPC in Ganga and Yamuna river water at Haridwar, Agra and Prayagraj indicate that river water are the major carriers of macro and microplastics through leakage routes identified from major hotspots.**

**Based on the collected secondary and primary data, an impact matrix for four states Uttarakhand, Uttar Pradesh, Bihar and West Bengal covering the main stem of the river and one town of Agra (Yamuna main stem) in Ganga Basin has been compiled (Table 1, Table 2, Table 3, Table 4) in Annexure 1. Analysis of these tables indicate that there is a big gap in the understanding of impact of macro & micro plastics on terrestrial ecology (air, soil, river bank and shoreline and aquatic and marine ecosystem in Ganga basin. Further, the impact of plastic pollution on the trophic linkage/food chain and ultimately health does not exist in the basin. In this context a number of counter measures can be developed at policy, program, plan and project level to overcome this gap. These countermeasures can be synergized with ongoing program, plan & project level interventions e.g. Clean India Mission, Namami Gange, Air Quality Monitoring Program, Ground Water Quality Program & Soil Health Card Program in India.**

## **21 A perspective regarding Plastic Waste Management Rules, in India and need for and indicative policy interventions arising**

Plastics have been focused upon via different rules or guidelines that have been developed for about two decades in India. An outline of the development of Rules and Guidelines and their features are presented in **Table 21.1** and **Figure 21.1**. The most recent rules have been in year 2016 known as Plastic Waste Management Rules, 2016, followed by amendments in 2018 and 2019.

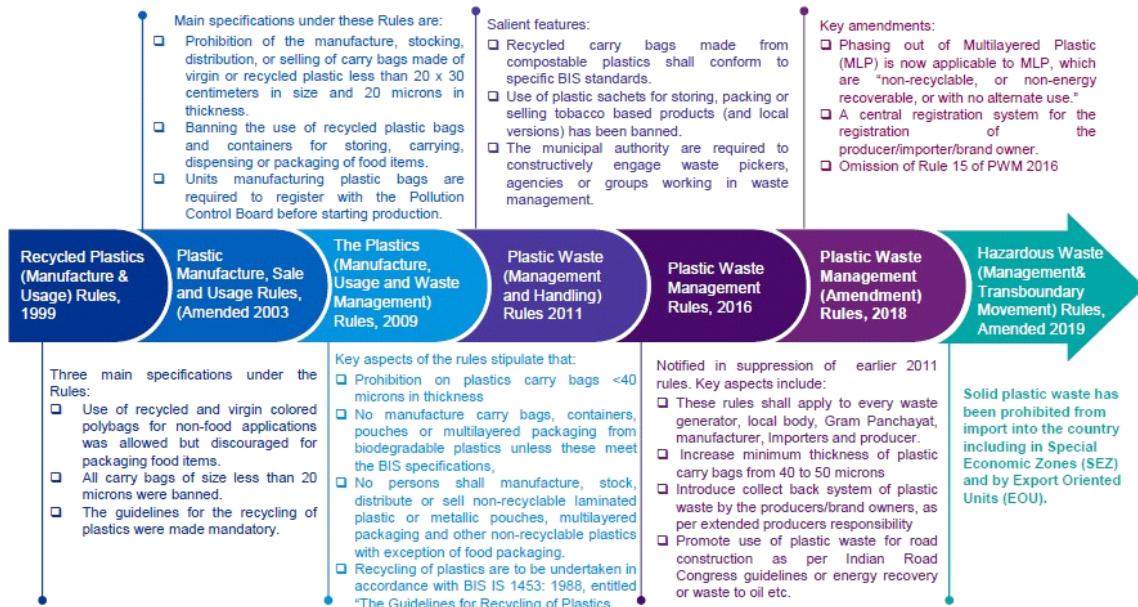
These rules define various aspects of plastics and their management, and various stakeholders and highlight the responsibilities. They apply to :

- Waste Generator
- Local Body
- Gram Panchayat
- Manufacturer
- Importer and brand owners
- Producer etc.

Table 21.1: Important legislations regarding Plastic Waste Management in India

<b>S. No.</b>	<b>Rules and Guidelines</b>
1	Specifications for compostable plastics ISO 17088:2012 2.
2	Guidelines for Recycling of Plastics ARE 14534:1998
3	Guidelines for the recovery and recycling of plastics waste ISO 15270:2013 4.
4	Sorting and Segregation of plastics IS 14535:1998 and ICPE Newsletter Vol 6, Issue 2, 2005 5
5	Manual on Solid Waste Management (2001), CPHEEO, Ministry of Urban development, GoI, New Delhi. MSWM, 2001
6	Plastic Waste (Management & Handling) Rules, 2011 2015
7	Method for the determination of the ultimate aerobic biodegradability of plastics, based on organic compounds, under controlled composting conditions by measurement of the amount of carbon dioxide evolved and the degree of disintegration of the plastic at the end of the test. ISO 14855:2012
8	Methods for the preparation of test samples used in the determination of the ultimate aerobic and anaerobic biodegradability of plastic materials in an aqueous medium, soil, controlled compost or anaerobic digesting sludge. ISO 10210:2012

Hereafter, have been the notification on Plastic Waste Management Rules in 2016 and amendments in 2018 and 2019. A picture of the key features of the plastic waste management regulations is as per following **Figure 21.1**.



**Figure 21.1: Progress on Plastic Waste Management Regulation in India**

**A Some of the features of the PWM 2016 rules concerning responsibilities of authorities / manufacturers and Consumers etc.**

An outline of the key responsibility features of various stakeholders is as per the tables and enumerations below.

**Prescribed Authorities for Plastic Waste Management and key responsibilities**

**Table 21.: Some of the authorities and their responsibilities under PWM, 2016**

S. No.	Prescribed Authority	Major Responsibilities
1.	SPCBs/PCCs	-Registration to producers, manufacturers & recyclers.  -Annual Report Submission to CPCB in Form-VI.
2.	Local Body	-Development and setting up of infrastructure for segregation,

		collection, storage, transportation, processing and disposal of plastic waste. -Frame bye-laws incorporating provisions of PWM Rules, 2016 -Submission of Annual Report by local body in Form-V.
3.	Secretary-in- Charge, UDD	-Enforcement of PWM Rules, 2016 relating to waste management use of plastic carry bags, plastic sheets or like, cover made up plastic sheets and multi-layered packaging.
4.	Gram Panchayat	-Set-up, operationalize and co-ordinate plastic waste management in rural areas.
5.	District Magistrate or Deputy Commissioner	-Providing assistance to SPCBs/PCCs, UDD, Gram Panchayat in enforcement of PWM Rules, 2016.

### **Responsibilities of Local Body and Gram Panchayats (Rules 5 & 6)**

- Setting up separate collection of bio-degradable (wet) and non-biodegradable (dry) waste like plastic.
- Ensuring open burning of plastic waste does not take place.
- Ensuring processing and disposal of plastic waste through Plastic Waste Management technologies.
- Ensuring channelization of recyclable plastic waste fraction to registered recyclers.
- Registration of shopkeepers and street vendors willing to provide plastic carry bags to the customers.
- Creating awareness among all stakeholders about their responsibilities.
- Setting-up of system for plastic waste management with the assistance of producers.
- Strengthened Local Bodies: Enforcement and Finance
  - Pricing of Plastic Carry bags- Funds to go Local Bodies
  - User Fee Collection
  - Spot Fines for Littering

## 22 Responsibilities of CPCB

Table 22.1: Key Responsibilities of Central Pollution Control Board

S. No.	Rule No.	Description	Action Taken
1	4(h)	The Manufacturers or Seller of compostable plastic carrybags shall obtain a certificate from the CPCB before marketing or selling their products.	Standard Operating Procedure (SOP) prepared and uploaded on CPCB's Website. Applications are processed as per SOP.
2	5(c)	Thermoset plastic waste shall be processed and disposed of as per the guidelines issued from time to time by the CPCB.	"Guidelines for disposal of thermoset plastic waste including SMC/FRP" uploaded on CPCB's website.
3	6(2)(d)	The Local Bodies shall ensure processing and disposal of non-recyclable fraction of plastic waste in accordance with the guidelines issued by the CPCB.	"Guidelines for Co-processing of Plastic Waste in Cement Kilns" uploaded on CPCB's website.
4	17(d)	The CPCB shall prepare a consolidated Annual Report on the use and management of plastic waste and forward it to MoEF&CC along with its recommendations before the 31st August of every year.	CPCB to submit Annual Report along with its recommendations to MoEFCC, by 31.08.2017.

### 22.1 Responsibilities of Brand Owners, Producers and Importers (As per Rule 9)

- Producers shall work out modalities for collect back system based on EPR involving State UDD, for plastic waste generated by their products (individually or collectively).
- Primary Responsibility of collection of multilayered plastic sheet or pouches or packaging of Producers, Importers & Brand Owners. An Action plan endorsed by Secretary-in-Charge, Urban Development Department, to be submitted to concerned SPCB/PCC while applying for consent to establish, Operate or Renewal.

- Phase-out use of non-recyclable plastic in two years time
- Producers within three months shall apply to SPCB/PCC for grant of registration.
- No Producer on an after of expiry of six month shall manufacture or use any plastic are multi-layered packaging without registration from SPCB/PCC.
- Producers shall maintain the record of plastic used as raw material to manufacture carrybags/ sheets etc.

## **22.2 State Level Monitoring Committee (SLMC) for Monitoring of Implementation of PWM Rules, 2016 (As per Rule 16)**

- State Government or the Union Territory shall constitute a State Level Monitoring Committee for effective Implementation of PWM Rules, 2016.
- SLMC Members: Secretary, UDD, representatives from SPCB/PCC, ULB, NGO, Industry, Academic Institution, State Tax Dept., Environment Dept. etc.
- SLMC shall meet at least once in six months & may invite experts, if necessary.
- The Secretary, Department of Urban Development shall be the Chairman of this committee.

## **22.3 The focus on Plastic Carry bags and Conditions for Plastic Bags**

As part of the PWM Rules, 2016, special attention has been given to plastic carry bags and related conditions are enumerated here.

- 1.) Carry bags and plastic packaging shall either be in natural shade which is without any added pigments or made using only those pigments and colorants which are in conformity with Indian (Standard : IS 9833:1981.)
- 2.) Carry bags made of recycled plastic or products made of recycled plastic shall not be used for ready to eat or drink food stuff.
- 3.) Carry bag made of virgin or recycled plastic, shall not be less than fifty microns in thickness.
- 4.) Plastic sheet or like, which is not an integral part of multilayered packaging and cover made of plastic sheet used for packaging, wrapping the commodity shall not be less than fifty microns in thickness.
- 5.) The manufacturer shall not sell or provide or arrange plastic to be used as raw material to a producer, not having valid registration.

- 6.) Sachets using plastic material shall not be used for storing, packing or selling gutkha, tobacco and pan masala.
- 7.) Recycling of plastic waste shall conform to the Indian Standard: IS 14534:1998 titled as Guidelines for Recycling of Plastics.
- 8.) The provision of thickness shall not be applicable to carry bags made up of compostable plastic. Carry bags made from compostable plastics shall conform to the Indian Standard: IS 17088:2008. The manufacturers or seller of compostable plastic carry bags shall obtain a certificate from the Central Pollution Control Board before marketing or selling; and
- 9.) Plastic material, in any form including Vinyl Acetate - Maleic Acid - Vinyl Chloride Copolymer, shall not be used in any package for packaging gutkha, pan masala and tobacco in all forms.

#### **22.4 Plastic Management Strategies in India**

The key initiatives that have occurred in India pertaining to management / reuse / recycling of plastics are enumerated below.

- ROAD CONSTRUCTION as per Indian Road congress guidelines
- ENERGY RECOVERY using waste plastic
- OIL RECOVERY using waste plastic through PYROLYSIS
- Co-processing in cement kilns as AFRs (estimated to lead to >80% energy recovery, 100% material recovery)

In addition to above range of efforts ongoing are the value added products being manufactured via recycling of plastics as highlighted in **Figure 22.1**. It is noted that apparels are being manufactured from recycled PET bottles, luggage from plastic from battery cases, mats from plastic carry bags and shoes from PVC pipes etc.

# VALUE ADDITION OF RECYCLED PLASTIC PACKAGING MATERIAL IN INDIA

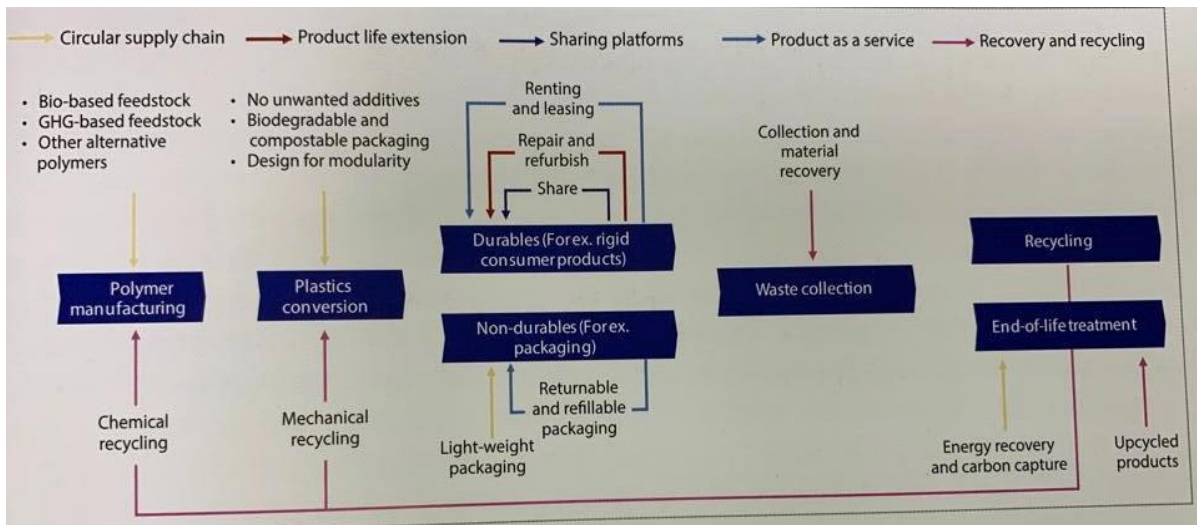


A thriving informal market for recycling plastics in India has emerged  
**HOWEVER, IS SUSCEPTIBLE TO MULTIPLE CHALLENGES.....**

**Figure 22.1: Nature of recycled plastic materials and products being developed in India (Mohanty, CIPET Presentation)**

## 22.5 Circular economy business models in plastics value chain and towards shaping innovative policies.

The scope for application of circular economy business models in Plastics sector has been emerging and growing and FICCI (2019) has highlighted the various components as per **Figure 22.2** below.





Besides the focus on addressing recycling systems, the importance of Bio – based feedstock, GHG based feedstock, other alternative polymers and inputs into polymer manufacturing and use of biodegradable and compostable packaging and design for modularity have been highlighted along with renting and leasing, repair and refurbishing and sharing models for durables and the use of light weight packaging and returnable and refillable packaging for non durables. The focus on efficient collection systems has also been emphasised. The appropriate business elements that would link to the framework need to evolve for any region and country specific scenario.

Further, the focus on Circular value chain from sourcing, manufacturing, logistics, marketing and sales, products use, end of life disposal and reverse logistics has been reflected upon. Towards the exploration of innovative policies the broad views identified include Material and Commodity View, and Product and Service View. As part of material and commodity view emphasis could be on Circular supply chain ( where attention could be on taxes on plastic production and packaging, recycling content standards, Eco- design standards etc) and regarding Recovery and recycling (focus on incentivisation of recycling industry, waste to energy business, plastic waste repurposing and upcycling) is indicated. In the domain of Product and Service View attention is sought on Sharing Platforms, Products as a service feature and product life extension. The incentives here could include Green Public Procurement, Policies supporting innovative product delivery models and Tax incentives and subsidies for product stewardship (FICCI, 2019).

As regards technologies to enable circular economy business models in plastics sector across the value chain FICCI (2019) highlights the role of Bio based materials, genetic engineering, carbon capture and storage and nano-technology for buttressing circular supply chain within the materials and commodity view and the scope for energy harvesting, advanced green chemistry, robotics, different spectroscopy applications, block chain use etc as part of recovery and recycling domain within the Material and Commodity view as well. Further, within the domain of product and service view the importance of applications of sensors and actuators, Modular design technology can find greater relevance to address the need for sharing platforms, product as a service and product life extension models.

Further, there is an emphasis on evolving suitable financing approaches via government funding, EPR funding and CSR funding etc and their roles in appropriate areas in circular business models and partnership systems at local level.

Table 22.2: Potential technology applications across the value chain (FICCI, 2019)

Polymer Plastics Manufacturing conversion	End-use industries consumption	Waste collection	Recycling and treatment
MATERIALS	CONSUMPTION MODELS	PLATFORMS	RECYCLING
<ul style="list-style-type: none"> <li>• Biodegradable and compostable plastics</li> <li>• Edible packaging</li> <li>• Bio-based feedstocks</li> <li>• Carbon-positive plastics</li> <li>• Nano and genetically-engineering recyclability</li> <li>• Reversible adhesives</li> <li>• Chemical markers</li> </ul>	<ul style="list-style-type: none"> <li>• Digital-enabled refillable packaging</li> <li>• IoT-enabled as-a-service models</li> <li>• Digital sharing platforms</li> </ul>	<ul style="list-style-type: none"> <li>• Mobile-app enabled waste collection</li> <li>• Reverse vending machines</li> <li>• Automated mixed waste segregators</li> <li>• Optical and AI-based sorting</li> <li>• GPS tracking of hauling vehicles</li> </ul>	<ul style="list-style-type: none"> <li>• Mechanical recycling</li> <li>• Depolymerization</li> <li>• Enzymatic digestion</li> </ul>
DESIGN		PROCESSES	TREATMENT
<ul style="list-style-type: none"> <li>• Organic coating for compostability</li> <li>• Magnetic coating for MLP replacements</li> <li>• Sustainable additive manufacturing</li> </ul>		<ul style="list-style-type: none"> <li>• Platform for EPR compliance management and data visualization</li> <li>• Platform for informal sector entities</li> <li>• Waste exchange platforms</li> </ul>	<ul style="list-style-type: none"> <li>• Waste to energy and fuel (Incineration, pyrolysis and gasification)</li> <li>• Upcycling technologies (for ex. Plastics waste to 3D printing filament, roofing material etc.)</li> </ul>

Source : FICCI report, 2019 “Making Plastics Circular”

## 23 Indicative Initiatives by Corporates / MNCs

In the process of addressing plastics waste management and contributing to the ongoing efforts in India and worldwide to reuse / recycle and replace plastics, some of the initiatives by corporate that have a bearing on India’s plastic waste management efforts are highlighted in Table 23.1. Evidently there is a need for public sector / government, private sector and civil society, besides contributions from researchers and various institutions that will enable the transition to improved plastics production / consumption and management practices.

Table 23.1: Corporate initiatives contributing to Plastic Waste management (Source FICCI report)

Sr. No.	Name	Commitments
1	Coca Cola	Collect and recycle the equivalent of every bottle or can it sells globally by 2030
2	Unilever	Ensure that all of its plastic packaging is fully reusable, recyclable or compostable by 2025
3	ITC Limited	Target 100% reusable, recyclable or compostable product packaging within the next decade
4	Nestle	Use minimum adequate packaging in its products through engagement with different stakeholders
5	Dabur	Strengthen the collection, segregation and recycling, co- processing of Multi-layered plastics
6	PEPSICO	Use 25% recycled content in its plastic packaging by 2025

## 24. Conclusion

The major polymers, their applications, specific composition and their hazards can impact terrestrial and aquatic environment if target groups are exposed to waste streams from riparian cities, which are mismanaged in any geographical boundary. For example plastic emissions from uncontrolled dump sites and effluent discharge into water bodies like lakes, rivers seas and oceans. If not properly collected, plastic waste can decay and cause air pollution and

degradation of soil, surface and groundwater, and aquatic and marine ecosystems. Micro plastics can also impact non-target species in soil biota. It can be summarized that impacts on terrestrial ecosystem include: (i) micro plastics may have adverse effects on and can be accumulated in soil organisms, ii) additives derived from micro plastics can be accumulated in soil organisms, iii) micro plastics can cause changes in the chemical contents of soil organisms, iv) responses of soil organisms exposed to micro plastics can cause changes in soil characteristics, v) chemicals adsorbed on micro plastics can enter the soil ecosystem, vi) micro plastics can move horizontally and vertically, (vii) plastic and micro plastics impact atmosphere and (viii) plastics and micro plastics can impact ground water. River is one of the main sources of plastic pollution carrying microplastics in the marine environment. Broadly marine wildlife is impacted by plastic pollution through entanglement, ingestion, bioaccumulation, and changes to the integrity and functioning of habitats. While macroplastic debris is the main contributor to entanglement, both micro and macrodebris are ingested across a wide range of marine species.

A big gap exists in the understanding of plastic leakage pathways and the impacts of macro & micro plastics on terrestrial ecology (air, soil, river bank and shoreline) and aquatic and marine ecosystem in Ganga basin. Further, the impact of plastic pollution on the trophic linkage/food chain and ultimately health does not exist since the basin has many ecosensitive zones/ stretches and serves as a major agriculture, horticulture and fishery base of India. In this context a number of counter measures can be developed at policy, program, plan and project level to overcome this gap. These countermeasures can be synergized with ongoing program, plan & project level interventions e.g. Clean India Mission, Namami Gange, Air Quality Monitoring Program, Ground Water Quality Program & Soil Health Card Program in India.

Table 1: Impact Matrix Uttarakhand

	Place / Attribute	Uttarkashi	Rishikesh	Haridwar	Evidence (A) / Gaps (NA)	Remarks
Terrestrial Ecosystem	Air	NA	NA	NA	NA	Haridwar has significant industrial area.
	Soil	NA	NA	NA	NA	Agriculture Area
	Ground Water	NA	NA	NA	NA	Agriculture Area
Aquatic & Marine Ecosystem	Near Banks & shoreline (Macro Plastic)	NA	A	A	Partial	Major Urban Centre
	Sediments on shoreline (Micro Plastics)	A	A	NA	Partial	River enters the plains from the hills
	River Water (Micro Plastics)	NA	NA	A	Partial	Effluent discharge (domestic & industrial)

Note:NA-Not Available, A-Available, P-Partial

Source: Jain Amit, Chief Technical Advisor, UNEP Project, NPC

Table 2: Impact Matrix Uttar Pradesh

	Place / Attribute	Bijnor	Anupshaha	Narora	Farukhabad	Kannauj	Kanpur	Allahabad	Mirzapur	Varanasi	Ghazipur	Etawa	Agra	Evidence (A) / Gaps (NA)	Remarks
Terrestrial Ecosystem	Air	NA	NA	NA	NA	NA	NA	NA	NA	NA	NA	NA	NA	NA	Allahabad & Varanasi are significant industrial area.
	Soil	NA	NA	NA	NA	NA	NA	NA	NA	NA	NA	NA	NA	NA	Major Agriculture Belt
	Ground Water	NA	NA	NA	NA	NA	NA	NA	NA	NA	NA	NA	NA	NA	Major Agriculture Belt
	Near Banks &	A	NA	NA	A	A	A	A	A	A	A	A	A	Partial	

	Place / Attribute	Bijnor	Anupshaha	Narora	Farukhabad	Kannauj	Kanpur	Allahabad	Mirzapur	Varanasi	Ghazipur	Etawa	Agra	Evidence (A) / Gaps (NA)	Remarks
Aquatic & Marine Ecosystem	shoreline (Macro Plastic)														
	Sediments on shoreline (Micro Plastics)	A	A	A	A	A	A	A	A	A	A	A	A	A	
	River Water (Micro Plastics)	NA	NA	NA	NA	NA	NA	A	NA	NA	NA	NA	A	Partial	<ul style="list-style-type: none"> <li>Kanpur, Varanasi, Mirzapur, Ghazipur, Balia are urban centres.</li> <li>NW 1 stretch</li> </ul>

Note:NA-Not Available, A-Available, P-Partial

Source: Jain Amit, Chief Technical Advisor, UNEP Project, NPC

**Table 3: Impact Matrix Bihar**

	Place / Attribute	Buxar	Chappra	Patna	Munger	Bhagalpur	Sahibganj	Haldia	Evidence (A) / Gaps (NA)	Remarks
Terrestrial Ecosystem	Air	NA	NA	NA	NA	NA	NA	NA	NA	Major Urban Centres
	Soil	NA	NA	NA	NA	NA	NA	NA	NA	Agriculture Area
	Ground Water Near Banks & shoreline (Macro	NA	NA	NA	NA	NA	NA	NA	NA	Domestic & Agriculture Use
		NA	NA	A	A	A	A	A	P	Major Urban Centres

	Place / Attribute	Buxar	Chappra	Patna	Munger	Bhagalpur	Sahibganj	Haldia	Evidence (A) / Gaps (NA)	Remarks
Aquatic & Marine Ecosystem	Plastics)									<ul style="list-style-type: none"> <li>Major Stretches are Dolphin Habitat &amp; Part of NW 1.</li> <li>Major urban centres</li> </ul>
	Sediments on shoreline(Micro Plastics)	A	A	A	A	A	A	A	A	
	River Water (Micro Plastics)	NA	NA	NA	NA	NA	NA	NA	NA	

Note:NA-Not Available, A-Available, P-Partial

Source: Jain Amit, Chief Technical Advisor, UNEP Project, NPC

**Table 4: Impact Matrix West Bengal**

	Place / Attribute	Farakka	Behrampur	Nabadip	Barrackpor	Kolkata	Goddakali	Haldia	Fraserganj	Evidence (A) / Gaps (NA)	Remarks
Terrestrial & Coastal Ecosystem	Air	NA	NA	NA	NA	NA	NA	NA	NA	NA	Kolkata is a major Urban Centre
	Soil	NA	NA	NA	NA	NA	NA	NA	NA	NA	Agriculture Belt
	Ground Water	NA	NA	NA	NA	NA	NA	NA	NA	NA	Drinking Water & Agriculture Source
	Near Banks & shoreline (Macro Plastics)	NA	NA	A	A	A	A	A	A	P	
Aquatic & Marine Ecosystem	Sediments on shoreline (Micro Plastics)	A	A	A	A	A	A	A	A	A	Sundarban is a major eco eco sensitive habitat
	River Water (Micro Plastics)	NA	NA	NA	NA	NA	NA	NA	NA	NA	Major Navigation Route (NW 1) & Sundarban is a major eco habitat

Note:NA-Not Available, A-Available, P-Partial

Source: Jain Amit, Chief Technical Advisor, UNEP Project, NPC

## **Bibliography**

1. Alonso-Magdalena, Paloma; Morimoto, Sumiko; Ripoll, Cristina; Fuentes, Esther; Nadal, Angel (January 2006). "The Estrogenic Effect of Bisphenol A Disrupts Pancreatic  $\beta$ -Cell Function In Vivo and Induces Insulin Resistance". *Environmental Health Perspectives*. 114 (1): 106–12.
2. Andersson Elin (2014). *Micro plastics in the oceans and their effect on the marine fauna*. Sverigeslantbruksuniversitet. Fakultetenförveterinärmedicinochhusdjursvetenskap <http://epsilon.slu.se>
3. Andrady, A. L. (2017). The plastic in microplastics:A review. *Marine Pollution Billiton*, 119, 12–22.CrossRefGoogle Scholar
4. Andrady AL, Neal MA (July 2009). "Applications and societal benefits of plastics". *Philos. Trans. R. Soc. Lond. B Biol. Sci.* 364 (1526): 1977–84.;
5. American Chemical Society National Historic Chemical Landmarks. "Bakelite: The World's First Synthetic Plastic".
6. Barnes, D. K. A.; Galgani, F.; Thompson, R. C.; Barlaz, M. (14 June 2009). "Accumulation and fragmentation of plastic debris in global environments". *Philosophical Transactions of the Royal Society B: Biological Sciences*. 364 (1526): 1985–1998. doi:10.1098/rstb.2008.0205. PMC 2873009. PMID 19528051.
7. Brandl, Helmut; Püchner, Petra (1992). "Biodegradation Biodegradation of plastic bottles made from 'Biopol' in an aquatic ecosystem under in situ conditions". *Biodegradation*. 2 (4): 237–43.).
8. Boucher, Julien & Friot, Damien. (2017). *Primary Microplastics in the Oceans: A Global Evaluation of Sources*. 10.2305/IUCN.CH.2017.01.en. [https://www.researchgate.net/publication/313900056\\_Primary\\_Microplastics\\_in\\_the\\_Oceans\\_A\\_Global\\_Evaluation\\_of\\_Sources](https://www.researchgate.net/publication/313900056_Primary_Microplastics_in_the_Oceans_A_Global_Evaluation_of_Sources)
9. Boucher Julien and Guillaume Billard, « The challenges of measuring plastic pollution », *Field Actions Science Reports* [Online], Special Issue 19 | 2019, Online since 01 March 2019, connection on 15 October 2019. URL : <http://journals.openedition.org/factsreports/5319> <https://journals.openedition.org/factsreports/pdf/5319>
10. Bolton, T. F., &Havenhand, J. N. (1998). Physiological versus viscosity-induced effects of an acute reduction in water temperature on microsphere ingestion by trochophore larvae of the serpulidpolychaete *Galeolaria caespitosa*. *Journal of Plankton Research*, 20, 2153– 2164.CrossRefGoogle Scholar
11. Cole, M., Lindeque, P., Fileman, E., Halsband, C., Goodhead, R., Moger, J., et al. (2013). Microplastic ingestion by zooplankton. *Environmental Science and Technology*, 47, 6646– 6655.CrossRefGoogle Scholar
12. CPCB report 2015. *Assessment & Quantification of Plastics Waste*



- Generation in Major Cities. Ministry of Environment and Forest. Pages 94.  
<http://www.indiaenvironmentportal.org.in/files/file/Assessment%20and%20Quantification%20of%20Plastics%20Waste.pdf> accessed 24 March 2020
13. CPCB Annual report 2017-18. Implementation Of Plastic Waste Management Rules. Pages 12.  
[http://www.indiaenvironmentportal.org.in/files/file/Annual\\_Report\\_2017-18\\_PWM.pdf](http://www.indiaenvironmentportal.org.in/files/file/Annual_Report_2017-18_PWM.pdf) accessed 24 March 2020
  14. CPCB, Gazette of India from. 2016 : Plastic Waste Management Rules, 2016. Pages 22.  
<http://www.indiaenvironmentportal.org.in/files/file/Plastic%20Waste%20Management%20Rules%202016.pdf> accessed 24 March 2020
  15. CPCB, 2017. Annual Report.  
[http://cpcbenvvis.nic.in/envvis\\_annual\\_report/Annual%20Progress%20Report%202017-18.pdf](http://cpcbenvvis.nic.in/envvis_annual_report/Annual%20Progress%20Report%202017-18.pdf) pages 26
  16. CPHEEO Manual. 2016. Swachh Bharat Mission. Municipal Solid Waste Management Manual. Part II. Pages 604.  
<http://cpheeo.gov.in/upload/uploadfiles/files/Part2.pdf>. Ministry of Urban Development 2016 Pages 604
  17. Cr dit Agricole. 2019. Plastic pollution is a global challenge.  
<https://www.credit-agricole.com/en/news-channels/the-channels/topic/2019/plastic-pollution-is-a-global-challenge>
  18. DaiZhenfei, Haibo Zhang, Qian Zhou, Yuan Tian, Tao Chen, Chen Tu, Chuancheng Fu, Yongming Luo. Occurrence of microplastics in the water column and sediment in an inland sea affected by intensive anthropogenic activities, *Environmental Pollution*, Volume 242, Part B, 2018, Pages 1557-1565, ISSN 0269-7491,  
<https://doi.org/10.1016/j.envpol.2018.07.131>.  
<http://www.sciencedirect.com/science/article/pii/S0269749118314775>)
  19. Debnath Biswajit . 2018. Aston University 61 PUBLICATIONS 173 CITA. Presentation . January 2018 DOI: 10.13140/RG.2.2.12644.42887  
[file:///D:/11\\_UNEP%20report/25march2020ch2DesktopRev/Debnath\\_PlasticManagementRules2016\\_Bhubaneshwar\\_3rdJanuray2018.pdf](file:///D:/11_UNEP%20report/25march2020ch2DesktopRev/Debnath_PlasticManagementRules2016_Bhubaneshwar_3rdJanuray2018.pdf)
  20. Driedger, Alexander G.J.; D rr, Hans H.; Mitchell, Kristen; Van Cappellen, Philippe (March 2015). "Plastic debris in the Laurentian Great Lakes: A review" (PDF). *Journal of Great Lakes Research*. 41 (1): 9–19. doi:10.1016/j.jglr.2014.12.020
  21. Ebbing, Darrell; Gammon, Steven D. (2016). *General Chemistry*. Cengage Learning. ISBN978-1-305-88729-9.
  22. Edgar, David; Edgar, Robin (2009). *Fantastic Recycled Plastic: 30 Clever Creations to Spark Your Imagination*. Sterling Publishing Company, Inc.

- ISBN978-1-60059-342-0 – via Google Books.;
23. El-Geziry and Bryden, 2010 The circulation pattern in the Mediterranean Sea issuesf or modeller Consideration, Journal of Operational Oceanography, 2010. Publication Date: Aug 2010. Publication Name: Journal of Operational Oceanography [https://www.academia.edu/4886866/El-Geziry\\_and\\_Bryden\\_2010\\_The\\_circulation\\_pattern\\_in\\_the\\_Mediterranean\\_Sea\\_issuesf\\_or\\_modeller\\_consideration](https://www.academia.edu/4886866/El-Geziry_and_Bryden_2010_The_circulation_pattern_in_the_Mediterranean_Sea_issuesf_or_modeller_consideration)
  24. Encyclopædia Britannica, Inc.Contributor: Ferdinand Rodriguez, Article Title: Plastic, Website Name: Encyclopædia Britannica, Publisher: Encyclopædia Britannica, inc.Date Published:December 09, 2019 URL:<https://www.britannica.com/science/plastic>, Access Date:March 25, 2020
  25. Enders K, Lenz R, Stedmon CA, Nielsen TG. Abundance, size and polymer composition of marine microplastics  $\leq 10\mu\text{m}$  in the Atlantic Ocean and their modelled vertical distribution. Mar Pollut Bull. 2015 Nov 15;100(1):70-81. doi: 10.1016/j.marpolbul.2015.09.027. Epub 2015 Oct 9. PMID:26454631
  26. EriksenMarcus,Laurent C. M. Lebreton,Henry S. Carson,Martin Thiel,Charles J. Moore,Jose C. Borerro,Francois Galgani,Peter G. Ryan,Julia Reisser. 2014. Plastic Pollution in the World's Oceans: More than 5 Trillion Plastic Pieces Weighing over 250,000 Tons Afloat at Sea. Published: December 10, 2014. <https://doi.org/10.1371/journal.pone.0111913> <https://journals.plos.org/plosone/article?id=10.1371/journal.pone.0111913> accessed 24 March 2020
  27. EUNOMIA, 2016. Eunomia Research & Consulting Ltd 37 Queen Square Bristol BS1 4QS United Kingdom. 2016. Plastics in the Marine Environment. <https://www.eunomia.co.uk/reports-tools/plastics-in-the-marine-environment/>
  28. FICCI report. 2014. Potential of plastics industry in northern India with special focus on plasticulture and food processing. A Report on Plastics Industry. Pages 42. <http://ficci.in/spdocument/20396/Knowledge-Paper-ps.pdf>
  29. FICCI report, 2019 "Making Plastics Circular".Circular Economy Symposium. Insights and Actions to Transform India's Plastic Waste Management. Mritunjay Kumar Jt. Director, Phone No.: 2348 7356 (D), +91 11 23738760-70 (Extn) Email: [mritunjay.kumar@ficci.com](mailto:mritunjay.kumar@ficci.com)
  30. Galie, Fabrizi (2016). "Global Market Trends and Investments in Polyethylene and Polypropylene"(PDF). ICIS Whitepaper. Reed business Information, Inc.
  31. GESAMP 2014. SOURCES, FATE AND EFFECTS OF MICROPLASTICS IN THE MARINE ENVIRONMENT: PART TWO OF A GLOBAL ASSESSMENT A report to inform the Second United Nations

Environment Assembly GESAMP Working Group 40 2nd phase. 221 pages. Published by the INTERNATIONAL MARITIME ORGANIZATION 4 Albert Embankment, London SE1 7SR [www.imo.org](http://www.imo.org) Printed by Micropress Printers Ltd <http://www.gesamp.org/site/assets/files/1275/sources-fate-and-effects-of-microplastics-in-the-marine-environment-part-2-of-a-global-assessment-en.pdf> HYPERLINK "<http://www.gesamp.org/site/assets/files/1275/sources-fate-and-effects-of-microplastics-in-the-marine-environment-part-2-of-a-global-assessment-en.pdf>" accessed 24 March 2020

32. Hahladakis, John N.; Velis, Costas A.; Weber, Roland; Iacovidou, Eleni; Purnell, Phil (February 2018). "An overview of chemical additives present in plastics: Migration, release, fate and environmental impact during their use, disposal and recycling". *Journal of Hazardous Materials*. 344: 179–199.)
33. Hammer, J; Kraak, MH; Parsons, JR (2012). "Plastics in the marine environment: the dark side of a modern gift". *Reviews of Environmental Contamination and Toxicology*. 220: 1– 44. doi:10.1007/978-1-4614-3414-6\_1. ISBN 978-1461434139. PMID 22610295.
34. Hans-Georg Elias. 2005. "Plastics, General Survey" in *Ullmann's Encyclopedia of Industrial Chemistry*, 2005, Wiley-VCH, Weinheim; Teuten EL, Saquing JM, Knappe DR, et al. (July 2009)."Transport and release of chemicals from plastics to the environment and to wildlife". *Philos. Trans. R. Soc. Lond. B Biol. Sci.* 364 (1526): 2027–45.)
35. Heeger, A.J.; Schrieffer, J.R.; Su, W.-P.; Su, W. (1988). "Solitons in conducting polymers". *Reviews of Modern Physics*. 60 (3): 781–850.)  
Henry George Liddell, Robert Scott, *A Greek-English Lexicon*, at Perseus. [Perseus.tufts.edu](http://Perseus.tufts.edu). Retrieved on 2011-07-01.
36. Hester, Ronald E.; Harrison, R. M. (editors) (2011). *Marine Pollution and Human Health*. Royal Society of Chemistry. pp. 84–85. ISBN 184973240X
37. Jambeck, Jenna R.; Geyer, Roland; Wilcox, Chris; et al. (2015). "Plastic HYPERLINK"  
"[https://www.iswa.org/fileadmin/user\\_upload/Calendar\\_2011\\_03\\_AMERICANA/Science-2015-Jambeck-768-71\\_\\_2\\_.pdf](https://www.iswa.org/fileadmin/user_upload/Calendar_2011_03_AMERICANA/Science-2015-Jambeck-768-71__2_.pdf)" HYPERLINK  
"[https://www.iswa.org/fileadmin/user\\_upload/Calendar\\_2011\\_03\\_AMERICANA/Science-2015-Jambeck-768-71\\_\\_2\\_.pdf](https://www.iswa.org/fileadmin/user_upload/Calendar_2011_03_AMERICANA/Science-2015-Jambeck-768-71__2_.pdf)"waste HYPERLINK  
"[https://www.iswa.org/fileadmin/user\\_upload/Calendar\\_2011\\_03\\_AMERICANA/Science-2015-Jambeck-768-71\\_\\_2\\_.pdf](https://www.iswa.org/fileadmin/user_upload/Calendar_2011_03_AMERICANA/Science-2015-Jambeck-768-71__2_.pdf)" HYPERLINK  
"[https://www.iswa.org/fileadmin/user\\_upload/Calendar\\_2011\\_03\\_AMERICANA/Science-2015-Jambeck-768-71\\_\\_2\\_.pdf](https://www.iswa.org/fileadmin/user_upload/Calendar_2011_03_AMERICANA/Science-2015-Jambeck-768-71__2_.pdf)"inputs HYPERLINK  
"[https://www.iswa.org/fileadmin/user\\_upload/Calendar\\_2011\\_03\\_AMERICANA/Science-2015-Jambeck-768-71\\_\\_2\\_.pdf](https://www.iswa.org/fileadmin/user_upload/Calendar_2011_03_AMERICANA/Science-2015-Jambeck-768-71__2_.pdf)" HYPERLINK  
"[https://www.iswa.org/fileadmin/user\\_upload/Calendar\\_2011\\_03](https://www.iswa.org/fileadmin/user_upload/Calendar_2011_03)

- \_AMERICANA/Science-2015-Jambeck-768-71\_\_2\_.pdf"from land into the ocean"(PDF).*Science*.347(6223): 768– 71. Bibcode:2015Sci...347..768 JHYPERLINK "<https://ui.adsabs.harvard.edu/abs/2015Sci...347..768J>". doi:10.1126/science.1260352HYPERLINK "<https://doi.org/10.1126%2Fscience.1260352>". PMID25678662.
38. Knight 2012. User, Super."Small, Smaller, Microscopic!". Retrieved 30 November 2017.
  39. Koelmans, Albert & Kooi, Merel & Law, Kara & Seville, Erik. (2017). All is not lost: Deriving a top-down mass budget of plastic at sea. *Environmental Research Letters*. 12. 10.1088/1748- 9326/aa9500.
  40. Kooi M, Nes EHV, Scheffer M, Koelmans AA. 2017. Ups and Downs in the Ocean: Effects of Biofouling on Vertical Transport of Microplastics. *Environ Sci Technol*. 2017;51(14):7963– 7971. doi:10.1021/acs.est.6b04702 <https://www.ncbi.nlm.nih.gov/pmc/articles/PMC6150669/pdf/es6b04702.pdf> accessed 24 March 2020
  41. Kukulka, T. & Proskurowski, G. & Morét, Skye & Meyer, D. & Law, Kara. (2012). The effect of wind mixing on the vertical distribution of buoyant plastic debris. *Geophysical Research Letters*. 39. 7601-. 10.1029/2012GL051116.
  42. Kulshreshtha, A. K.; Vasile, Cornelia (2002). *Handbook of Polymer Blends and Composites*. iSmithers Rapra Publishing. ISBN 978-1-85957-249-8.
  43. Kutz, Myer (2002). 35924-1
  44. *Handbook of Materials Selection*. John Wiley & Sons. ISBN 978-0-471-
  45. Lebreton et al. 2017. (Lebreton, L. C. M. et al. River plastic emissions to the world's oceans, 2017
  46. Lebreton Eriksen, M., L. C. M., Carson, H. S., Thiel, M., Moore, C. J., et al. (2014). Plastic pollution in the world's oceans: More than 5 trillion plastic pieces weighing over 250,000 tons afloat at Sea. *PLoS ONE*, 9, 111913. CrossRef Google Scholar
  47. Lisa Wade McCormick. 2009. More Kids' Products Found Containing Unsafe Chemicals, *ConsumerAffairs.com*, October 30, 2009.
  48. Le Guern, Claire (March 2018). "When The Mermaids Cry: The Great Plastic Tide". *Coastal Care*. Archived from the original on 5 April 2018. Retrieved 10 November 2018.
  49. Mathieu-Denoncourt, Justine; Wallace, Sarah J.; de Solla, Shane R.; Langlois, Valerie S. (November 2014). "Plasticizer endocrine disruption: Highlighting developmental and reproductive effects in mammals and non-mammalian aquatic species". *General and Comparative Endocrinology*. 219: 74–88. doi:10.1016/j.ygcen.2014.11.003. PMID 25448254.
  50. McRandle, P.W. (March–April 2004). "Plastic Water Bottles". *National Geographic*.
  51. Mohanty Smita. 2018. Director (Principal Scientist), CIPET:SARP-

- APDDRL, Bengaluru, Department of Chemicals & Petrochemicals, Ministry of Chemicals & Fertilizers, Govt. of India, Presentation @ UNIDO Office, VIC, Vienna. file:///D:/11\_UNEP%20report/25march2020ch2DesktopRev/Plenary%20%20-%20Plastics%20-%20Mohanty.pdf accessed 24 March 2020
52. MoHUA, 2018. Annual Report 2018-19. Government of India. Ministry of Housing and Urban Affairs. Pages 105.  
<http://mohua.gov.in/upload/uploadfiles/files/AR201819-1-105.pdf> accessed 24 March 2020
  53. MoHUA report. 2019. Plastic Waste Management Issues, Solutions & Case Studies. Pages 84  
[http://164.100.228.143:8080/sbm/content/writereaddata/SBM%20Plastic%20Waste%20Bo ok.pdf](http://164.100.228.143:8080/sbm/content/writereaddata/SBM%20Plastic%20Waste%20Bo%20ok.pdf) accessed 24 March 2020
  54. Nitin H. Mutha, Martin Patel, V. Premnath (2006). Plastics Materials flow analysis for India. Elsevier, Resources Conservation and Recycling,47, 2006, PP 222-244.
  55. Nomadic, Global (29 February 2016). "Turning rubbish into money – environmental innovation leads the way".
  56. Otaga, Y. (2009). "International Pellet Watch: Global monitoring of persistent organic pollutants (POPs) in coastal waters. 1. Initial phase data on PCBs, DDTs, and HCHs" (PDF). Marine Pollution Bulletin. 58 (10): 1437–46.
  57. Pettipas, Shauna; Bernier, Meagan; Walker, Tony R. (2016). "A Canadian policy framework to mitigate plastic marine pollution". Marine Policy. 68: 117–22. doi:10.1016/j.marpol.2016.02.025.
  58. Plastindia Foundation report 2018. Report on The Indian Plastics Industry  
Plastindia Foundation presents - Data on Indian Plastics Industry 2019 - Statistics, Overview & Forecast  
<https://www.plastindia.org/plastic-industry-status-report.html> accessed 24 March 2020
  59. P, Kaladharan & Vijayakumaran, Kandachamy & Singh, V. & Prema, D. & P S, Asha & Sulochanan, Bindu &Hemasankari, P. & Edward, Loveson & Padua, Shelton & Shettigar, Veena & Anasukoya, Ashiyoda & Bhint, H.. (2017). Prevalence of marine litter along the Indian beaches : A preliminary account on its status and composition. Journal of the Marine Biological Association of India. 59. 19-24. 10.6024/jmbai.2017.59.1.1953-03.
  60. Reuters : News, World Oceans Day, Reuters, June 08, 2017 4:21 PM  
<https://swachhindia.ndtv.com/world-oceans-day-5-trillion-pieces-of-plastic-floating-in-worlds-oceans-8548/>
  61. Rubin, BS; Murray, MK; Damassa, DA; King, JC; Soto, AM. 2001. "Perinatal exposure to low doses of bisphenol A affects body weight, patterns of estrous cyclicity, and plasma LH levels". Environmental Health Perspectives.

- 109 (7): 675–80;
62. SarkarDhruba Jyoti, Soma Das Sarkar, Basanta Kumar Das , Ranjan Kumar Manna, Bijay Kumar Behera, SrikantaSamanta. ICAR-Central Inland Fisheries Research Institute, Kolkata, 700120, India. 2019. Spatial distribution of meso and microplastics in the sediments of river Ganga at eastern India. Elsevier. *Science of the Total Environment* 694 (2019) 133712
  63. SchmidtChristian, Tobias Krauthand StephanWagner. 2017. Export of Plastic Debris by Rivers into the Sea. *Environmental Science & Technology* 2017 51 (21), 12246-12253 DOI: 10.1021/acs.est.7b02368  
<https://www.gwern.net/docs/economics/2017-schmidt.pdf> ACCESSED 24 March 2020
  64. Seymour, Raymond Benedict; Deaning, Rudolph D. (1987). *History of Polymeric Composites*. VSP.)
  65. Sri SasiJyothsna T., Chakradhar B. (2020) Current Scenario of Plastic Waste Management in India: Way Forward in Turning Vision to Reality. In: Ghosh S. (eds) *Urban Mining and Sustainable Waste Management*. Springer, Singapore. First Online 18 March 2020. DOI [https://doi.org/10.1007/978-981-15-0532-4\\_21](https://doi.org/10.1007/978-981-15-0532-4_21). Print ISBN 978-981-15-0531-7. Online ISBN 978-981-15-0532-4
  66. Sukhdhane, K.S., V. Kripa, S.P. Shukla, K.R. Sreenath, Divu Damodaran and Vinay Kumar Vase. 2019. Assessment of Marine Litter along Four Sandy Beaches of Saurashtra Coast, Gujarat. *Int.J.Curr.Microbiol.App.Sci.* 8(06): 2623-2632. doi: <https://doi.org/10.20546/ijcmas.2019.806.315>
  67. Sutter, John D. (12 December 2016). "How to stop the sixth mass extinction". CNN. Retrieved 18 September 2017.
  68. Teegarden, David M. (2004). *Polymer Chemistry: Introduction to an Indispensable Science*. NSTA Press. ISBN 978-0-87355-221-9 – via Google Books
  69. TERI report. 2018. Fact Sheet on plastic waste in India. <https://www.teriin.org/sites/default/files/files/factsheet.pdf> accessed 24 March 2020
  70. TERI. Challenges and Opportunities. Plastic Waste Management in India. Pages 20. R R N Sailaja Bhattacharya , Kaushik Chandrasekhar, M V Deepthi, Pratik Roy, and Ameen Khan  
[https://www.teriin.org/sites/default/files/2018-06/plastic-waste-management\\_0.pdf](https://www.teriin.org/sites/default/files/2018-06/plastic-waste-management_0.pdf)
  71. Teuten EL, Saquing JM, Knappe DR, et al. (July 2009). "Transport and release of chemicals from plastics to the environment and to wildlife". *Philos. Trans. R. Soc. Lond. B Biol. Sci.* 364 (1526): 2027–45.).
  72. Teuten, E. L., Saquing, J. M., Knappe, D. R. U., Barlaz, M. A., Jonsson,

- S., et al. (2009). Transport and release of chemicals from plastics to the environment and to wildlife. *Philosophical Transactions of the Royal Society B: Biological Sciences*, 364, 2027– 2045. CrossRefGoogle Scholar
73. The Economist. 3 March 2018. "The known unknowns of plastic pollution". <https://www.economist.com/international/2018/03/03/the-known-unknowns-of-plastic-pollution> accessed 24 March 2020
74. Toxics link. (2014). Plastics and the environment assessing the impact of the complete ban on plastic carry bag. Central Pollution Control Board (CPCB New Delhi India). <http://toxicslink.org/docs/Full-Report-Plastic-and-the-Environment.pdf>
75. Tullo Alexander H. (2018). Fighting ocean plastics at the source. APRIL 16, 2018 | APPEARED IN VOLUME 96, ISSUE 16. <https://cen.acs.org/materials/polymers/Fighting-ocean-plastics-source/96/i16>
76. UNEP. (2005). Marine litter, an analytical overview. Nairobi: United Nations Environment Programme. Google Scholar. Pages 58. <http://wedocs.unep.org/bitstream/handle/20.500.11822/8348/-Marine%20Litter%2c%20an%20analytical%20overview-20053634.pdf?sequence=3&isAllowed=y> accessed 24 March 2020
77. UNEP (2015) Report, titled 'Global Waste Management Outlook'. ISBN: 978-92-807-3479-9 DTI /1957/JA. Pages 346 <https://www.unclearn.org/sites/default/files/inventory/unep23092015.pdf>
78. UN Environment, 2018. Putting the Environment at the heart of people's Lives. Pages 44. [https://wedocs.unep.org/bitstream/handle/20.500.11822/27689/AR2018\\_EN.pdf?sequence=1&isAllowed=y](https://wedocs.unep.org/bitstream/handle/20.500.11822/27689/AR2018_EN.pdf?sequence=1&isAllowed=y)
79. Van Cauwenberghe, L., Claessens, M., Vandegehuchte, M., & Janssen, C. R. (2015). Microplastics are taken up by mussels (*Mytilus edulis*) and lugworms (*Arenicola marina*) living in natural habitats. *Environmental Pollution*, 199, 10–17. CrossRefGoogle Scholar
80. Van Cauwenberghe, L., Vanreusel, A., Mees, J., & Janssen, C. R. (2013). Microplastic pollution in deep-sea sediments. *Environmental Pollution*, 182, 495–499. CrossRefGoogle Scholar
81. van Sebille Erik, Chris Wilcox, Laurent Lebreton, Nikolai Maximenko, Britta Denise Hardesty, Jan A van Franeker, Marcus Eriksen, David Siegel, Francois Galgani and Kara Lavender Law. 2015. A global inventory of small floating plastic debris. Published 8 December 2015 • © 2015 IOP Publishing Ltd *Environmental Research Letters*, Volume 10, Number 12 <https://iopscience.iop.org/article/10.1088/1748-9326/10/12/124006/pdf> accessed 24 March 2020

82. Vanitha V., G.Sarath Chandra<sup>1</sup> and A.P.Nambi (2010). Tamilnadu J. Veterinary & Animal Sciences 6 (2) 71-74, March - April 2010
83. Vidyasakar A., K. Neelavannan, S. Krishnakumar, G. Prabakaran, T. Sathiyabama Alias Priyanka, N.S. Magesh, Prince S. Godson, S. Srinivasalu. (2018). Macrodebris and microplastic distribution in the beaches of Rameswaram Coral Island, Gulf of Mannar, Southeast coast of India: A first report. Elsevier. Science Direct. Marine Pollution Bulletin 137 (2018) 610-616. <https://doi.org/10.1016/j.marpolbul.2018.11.007>
84. Von Moos, N., Burkhardt-Holm, P., & Koehler, A. (2012). Uptake and effects of microplastics on cells and tissues of the blue mussel *Mytilus edulis* L. after experimental exposure. Environmental Science and Technology, 46, 11327–11335. CrossRefGoogle Scholar
85. Walker, T.R.; Reid, K.; Arnould, J.P.Y.; Croxall, J.P. (1997). "Marine debris surveys at Bird Island, South Georgia 1990–1995". Marine Pollution Bulletin. 34: 61–65. doi:10.1016/S0025-326X(96)00053-7.
86. Walker, Tony R.; Xanthos, Dirk (2018). "A call for Canada to move toward zero plastic waste by reducing and recycling single-use plastics". Resources, Conservation and Recycling. 133: 99–100. doi:10.1016/j.resconrec.2018.02.014.
87. Woodall LC et al. 2014 The deep sea is a major sink for microplastic debris. R. Soc. open sci.1: 140317. <http://dx.doi.org/10.1098/rsos.140317> <https://royalsocietypublishing.org/doi/full/10.1098/rsos.140317> accessed 24 March 2020
88. World Economic Forum (WEF). 2016. The New Plastics Economy Rethinking the future of plastics. Pages 36 [http://www3.weforum.org/docs/WEF\\_The\\_New\\_Plastics\\_Economy.pdf](http://www3.weforum.org/docs/WEF_The_New_Plastics_Economy.pdf)
89. Wright, S. L., Thompson, R. C., & Galloway, T. S. (2013). The physical impacts of microplastics on marine organisms: A review. Environmental Pollution, 178, 483–492. CrossRefGoogle Scholar
90. Xiaoning Yang. 2013. Pyrolysis and dehalogenation of plastics from Waste Electrical and Electronic Equipment (WEEE), A review 2013.
91. Yang, Chun Z.; Yaniger, Stuart I.; Jordan, V. Craig; Klein, Daniel J.; Bittner, George D. (2011). "Most Plastic Products Release Estrogenic Chemicals: A Potential Health Problem That Can Be Solved". Environmental Health Perspectives. 119 (7): 989–96.).

**Weblinks and/or html links :-**

92. Plastic, Online Etymology Dictionary. Etymonline.com
93. <https://en.wikipedia.org/wiki/Plastic>, 28 February 2020
94. <https://en.wikipedia.org/wiki/Plastic> accessed 22 March 2020 Life cycle of a plastic product. Americanchemistry.com "The monster footprint of digital



- technology". Low-Tech Magazine. Retrieved 2017-04-18.
95. "How much energy does it take (on average) to produce 1 kilogram of the following materials?". Low-Tech Magazine.  
<https://en.wikipedia.org/wiki/Plastic> accessed 28 February 2020.
  96. UK Patent office (1857). Patents for inventions. UK Patent office. p. 255.)  
[https://en.wikipedia.org/wiki/Timeline\\_of\\_plastic\\_development](https://en.wikipedia.org/wiki/Timeline_of_plastic_development) accessed 26 Feb 2020
  97. Classification of Plastics Archived 2007-12-15 at the Wayback Machine.  
Dwb.unl.edu. Periodic Table of Polymers Dr Robin Kent – Tangram Technology Ltd.
  98. <https://omnexus.specialchem.com/selection-guide/polyethylene-terephthalate-pet-plastic> accessed 13 March 2020
  99. [https://en.wikipedia.org/wiki/List\\_of\\_synthetic\\_polymers](https://en.wikipedia.org/wiki/List_of_synthetic_polymers) accessed 26 February 2020
  100. (<https://www.britannica.com/science/plastic/Foaming> accessed 17 March 2020  
<https://www.chem1.com/acad/webtext/states/polymers.html>  
Weblink : "How much energy does it take (on average) to produce 1 kilogram of the following materials?". Low-Tech Magazine
  101. <http://theconversation.com/the-world-of-plastics-in-numbers-100291> accessed 17 March 2020 as part of a report on the world of plastics in numbers
  102. [https://en.wikipedia.org/wiki/Plastic\\_pollution](https://en.wikipedia.org/wiki/Plastic_pollution) accessed 19 March 2020 "Plastic pollution". Encyclopædia Britannica. Retrieved 1 August 2013. Laura Parker (June 2018). "We Depend on Plastic. Now We're Drowning in It". NationalGeographic.com. Retrieved 25 June 2018.
  103. unenvironment.org. 18 May 2018. "Picking up litter: Pointless exercise or powerful tool in the battle to beat plastic pollution?". Retrieved 19 July 2019.
  104. <https://packaging360.in/news/india-produces-25-000-tonnes-of-plastic-waste-daily--40--uncollected--says-accessed> 23 March 2020
  105. <https://economictimes.indiatimes.com/news/politics-and-nation/how-india-is-drowning-in-plastic/articleshow/69706090.cms> accessed 24 March 2020
  106. UN Environment (2018); Exploring the Potential for Adopting Alternative Materials to Reduce Marine Plastic Litter;  
<https://www.unenvironment.org/resources/report/exploring-potential-adopting-alternative-materials-reduce-marine-plastic-litter>
  107. OECD (2018); Improving Markets for Recycled Plastics – Trends, Prospects and Policy Responses;  
<https://www.kunststofenrubber.nl/download/OECD%20recycled%20Plastics%202018%20rapport.pdf>
  108. Lithner, D., Larsson, Å. and Dave, G. (2011). Environmental and health hazard ranking and assessment of plastic polymers based on chemical composition.

- Science of the Total Environment 409(18), 3309-3324.  
<https://doi.org/10.1016/j.scitotenv.2011.04.038>.
109. Yooeun Chae, Youn – Joo An; Department of Environment Health Science, Konkuk University; Current Research Trends on Plastic Pollution and Ecological Impacts on the Soil Ecosystem: A review (Environmental Pollution 240 [2018] 387 – 395
  110. Carr, S.A., Liu, J., Tesoro, A.G., 2016. Transport and fate of microplastic particles in wastewater treatment plants. *Water Res.* 91, 174e182.
  111. Mason, S.A., Garneau, D., Sutton, R., Chu, Y., Ehmann, K., Barnes, J., Rogers, D.L., 2016. Microplastic pollution is widely detected in US municipal wastewater treatment plant effluent. *Environmental Pollution* 218, 1045e1054.
  112. McCormick, A.R., Hoellein, T.J., London, M.G., Hittie, J., Scott, J.W., Kelly, J.J., 2016. Microplastic in surface waters of urban rivers: concentration, sources, and associated bacterial assemblages. *Ecosphere* 7.
  113. Talvitie, J., Mikola, A., Setälä, O., Heinonen, M., Koistinen, A., 2017. How well is microlitter purified from wastewater? A detailed study on the stepwise removal of microlitter in a tertiary level wastewater treatment plant. *Water Res.* 109, 164e172.
  114. Ziajahromi, S., Neale, P.A., Rintoul, L., Leusch, F.D., 2017. Wastewater treatment plants as a pathway for microplastics: development of a new approach to sample wastewater-based microplastics. *Water Res.* 112, 93e99.
  115. Nizzetto, L., Futter, M., Langaas, S., 2016a. Are agricultural soils dumps for microplastics of urban origin? *Environ. Sci. Technol.* 50, 10777e10779.
  116. Horton, A.A., Walton, A., Spurgeon, D.J., Lahive, E., Svendsen, C., 2017. Microplastics in freshwater and terrestrial environments: evaluating the current understanding to identify the knowledge gaps and future research priorities. *Sci. Total Environ.* 586, 127e141.
  117. Nizzetto, L., Bussi, G., Futter, M.N., Butterfield, D., Whitehead, P.G., 2016b. A theoretical assessment of microplastic transport in river catchments and their retention by soils and river sediments. *Environ. Sci. Process Impacts* 18, 1050e1059.
  118. Bl€asing, M., Amelung, W., 2018. Plastics in soil: analytical methods and possible sources. *Sci. Total Environ.* 612, 422e435.
  119. Kasirajan, S., Ngouajio, M., 2012. Polyethylene and biodegradable mulches for agricultural applications: a review. *Agron. Sustain. Dev.* 32, 501e529.
  120. Li, C., Moore-Kucera, J., Lee, J., Corbin, A., Brodhagen, M., Miles, C., Inglis, D., 2014b. Effects of biodegradable mulch on soil quality. *Appl. Soil Ecol.* 79, 59e69.
  121. Farmer, J., Zhang, B., Jin, X., Zhang, P., Wang, J., 2017. Long-term effect of plastic film mulching and fertilization on bacterial communities in a brown soil revealed by high through-put sequencing. *Arch. Agron. Soil Sci.* 63, 230e241.
  122. Sintim, H.Y., Flury, M., 2017. Is biodegradable plastic mulch the solution to

- agriculture's plastic problem? *Environ. Sci. Technol.* 51, 1068e1069.
123. Dubaish, F., Liebezeit, G., 2013. Suspended microplastics and black carbon particles in the Jade system, southern North Sea. *Water Air Soil Pollut.* 224, 1352.
  124. Foitzik, M.J., Unrau, H.J., Gauterin, F., D€ornh€ofer, J., Koch, T., 2018. Investigation of ultra fine particulate matter emission of rubber tires. *Wear* 394, 87e95.
  125. Wagner, S., H€uffer, T., Kl€ockner, P., Wehrhahn, M., Hofmann, T., Reemtsma, T., 2018. Tire wear particles in the aquatic environment-a review on generation, analysis, occurrence, fate and effects. *Water Res.* 139, 83e100.
  126. Dris, R., Gasperi, J., Saad, M., Mirande, C., Tassin, B., 2016. Synthetic fibers in atmospheric fallout: a source of microplastics in the environment? *Mar. Pollut. Bull.* 104, 290e293.
  127. Rachid Dris, Johnny Gasperi, Mohamed Saad, Cécile Mirande, Bruno Tassin; Synthetic fibers in atmospheric fallout: A source of microplastics in the environment (2016)
  128. Free, C.M., Jensen, O.P., Mason, S.A., Eriksen, M., Williamson, N.J., Boldgiv, B., 2014. High levels of microplastic pollution in a large, remote, mountain lake. *Mar. Pollut. Bull.* 85, 156–163. <http://dx.doi.org/10.1016/j.marpolbul.2014.06.001>.
  129. Rillig, M.C., 2012. Microplastic in terrestrial ecosystems and the soil? *Environ. Sci. Technol.* 46, 6453e6454
  130. Liu, E.K., He, W.Q., Yan, C.R., 2014. 'White revolution'to 'white pollution'dagricultural plastic film mulch in China. *Environ. Res. Lett.* 9, 091001.
  131. Rochman, C.M., Kross, S.M., Armstrong, J.B., Bogan, M.T., Darling, E.S., Green, S.J., Smyth, A.R., Verissimo, D., 2015. Scientific evidence supports a ban on microbeads. *Environ. Sci. Technol.* 49, 10759e10761.
  132. Huerta Lwanga, E., Gertsen, H., Gooren, H., Peters, P., Sal\_anki, T., van der Ploeg, M., Besseling, E., Koelmans, A.A., Geissen, V., 2016. Microplastics in the terrestrial ecosystem: implications for *Lumbricus terrestris* (Oligochaeta, Lumbricidae). *Environ. Sci. Technol.* 50, 2685e2691.
  133. Gaylor, M.O., Harvey, E., Hale, R.C., 2013. Polybrominated diphenyl ether (PBDE) accumulation by earthworms (*Eisenia fetida*) exposed to biosolids-, polyurethane foam microparticle-, and Penta-BDE-amended soils. *Environ. Sci. Technol.* 47, 13831-13839.
  134. Chen, Y., Wu, C., Zhang, H., Lin, Q., Hong, Y., Luo, Y., 2013. Empirical estimation of pollution load and contamination levels of phthalate esters in agricultural soils from plastic film mulching in China. *Environ. Earth Sci.* 70, 239.
  135. Hong, S.H., Shim, W.J., Hong, L., 2017. Methods of analysing chemicals associated with microplastics: a review. *Anal. Methods* 9, 1361-1368.
  136. Rillig, M.C., Ziersch, L., Hempel, S., 2017a. Microplastic transport in soil by earthworms. *Sci. Rep.* 7, 1362.

137. Scheurer, M., Bigalke, M., 2018. Microplastics in Swiss floodplain soils. *Environ. Sci. Technol.* 52, 3591e3598.
138. Christine Wiedinmyer et al, "Global Emissions of Trace Gases, Particulate Matter, and Hazardous Air Pollutants from Open Burning of Domestic Waste", *Environmental Science and Technology* 2014, 48 (16), 9525.
139. Huerta Lwanga, E., Vega, J.M., Quej, V.K., de los Angeles Chi, J., del Cid, L.S., Chi, C., Segura, G.E., Gertsen, H., Sa\_anki, T., van der Ploeg, M., Koelmans, A.A., Geissen, V., 2017b. Field evidence for transfer of plastic debris along a terrestrial food chain. *Sci. Rep.* 7, 14071.
140. Law, K.L., Thompson, R.C., 2014. Microplastics in the seas. *Science* 345 (6193), 144–145.
141. Moore, C.J., Lattin, G.L., Zellers, A.F., 2005. A brief analysis of organic pollutants sorbed to pre and post-production plastic particles from the Los Angeles and San Gabriel river Watersheds. *Proceedings of the Plastic Debris Rivers to Sea Conference.* Algalita Marine Research Foundation, Long Beach, CA
142. Lechner, A., Keckeis, H., Lumesberger-Loisl, F., Zens, B., Krusch, R., Tritthart, M., Glas, M., Schludermann, E., 2014. The Danube so colourful: a potpourri of plastic litter outnumbers fish larvae in Europe's second largest river. *Environ. Pollut.* 188, 177–181.
143. Zhao, S., Zhu, L., Wang, T., Li, D., 2014. Suspended microplastics in the surface water of the Yangtze Estuary System, China: first observations on occurrence, distribution. *Mar. Pollut. Bull.* 86 (1–2), 562–568.
144. Mani, T., Hauk, A., Walter, U., Burkhardt-Holm, P., 2015. Microplastics profile along the Rhine River. *Sci. Rep.* 5, 17988.
145. Battulga, B., Kawahigashi, M., Oyuntsetseg, B., 2019. Distribution and composition of plastic debris along the river shore in the Selenga River basin in Mongolia. *Environ. Sci. Pollut. Res.* 1–14.
146. Tan, X., Yu, X., Cai, L., Wang, J., Peng, J., 2019. Microplastics and associated PAHs in surface water from the Feilaixia Reservoir in the Beijiing River, China. *Chemosphere* 221, 834–840.
147. Alam, F.C., Sembiring, E., Muntalif, B.S., Suendo, V., 2019. Microplastic distribution in surface water and sediment river around slum and industrial area (case study: Ciwalengke River, Majalaya district, Indonesia). *Chemosphere* 224, 637–645.
148. Carpenter, E.J., Smith Jr., K.L., 1972. Plastics on the Sargasso Sea surface. *Science* 175, 1240–1241.
149. Derraik JGB (2002) The pollution of the marine environment by plastic debris: a review. *Mar Pollut Bull* 44: 842–852
150. Barnes, D.K.A., Galgani, F., Thompson, R.C., Barlaz, M., 2009. Accumulation and

- fragmentation of plastic debris in global environments. *Philos. Trans. R. Soc. B* 364, 1985–1998.
151. Ivar do Sul JA, Costa MF (2014) The present and future of microplastic pollution in the marine environment. *Environ Pollut* 185: 352–364
  152. Lusher A, Hollman P, Mendoza-Hill J. Microplastics in fisheries and aquaculture: status of knowledge on their occurrence and implications for aquatic organisms and food safety. *FAO Fisheries and Aquaculture Technical Paper* 2017;(615).
  153. Laist DW (1987) Overview of the biological effects of lost and discarded plastic debris in the marine environment. *Mar Pollut Bull* 18: 319–326
  154. Laist DW (1997) Impacts of marine debris: entanglement of marine life in marine debris including a comprehensive list of species with entanglement and ingestion records. In: Coe J, Rogers D (eds) *Marine debris: sources, impacts, and solutions*. Springer-Verlag, New York, NY, p 99–139
  155. Page B, Mckenzie J, McIntosh R, Baylis A and others (2004) Entanglement of Australian sea lions and New Zealand fur seals in lost fishing gear and other marine debris before and after government and industry attempts to reduce the problem. *Mar Pollut Bull* 49: 33–42
  156. van Franeker JA, Blaize C, Danielsen J, Fairclough K and others (2011) Monitoring plastic ingestion by the northern fulmar *Fulmarus glacialis* in the North Sea. *Environ Pollut* 159: 2609–2615
  157. Beck CA, Barros NB (1991) The impact of debris on the Florida manatee. *Mar Pollut Bull* 22: 508–510
  158. Tomás J, Guitart R, Mateo R, Raga JA (2002) Marine debris ingestion in loggerhead sea turtles, *Caretta caretta* from the western Mediterranean. *Mar Pollut Bull* 44: 211–216
  159. Wabnitz CCC, Nichols WJ (2010) Plastic pollution: an ocean emergency. *Mar Turtle Newsl* 129: 1–4
  160. Guebert-Bartholo FM, Barletta M, Costa MF, Monteiro-Filho ELA (2011) Using gut contents to assess foraging patterns of juvenile green turtles *Chelonia mydas* in the Paranaguá Estuary, Brazil. *Endang Species Res* 13: 131–143
  161. Lazar B, Gračan R (2011) Ingestion of marine debris by loggerhead sea turtles, *Caretta caretta*, in the Adriatic Sea. *Mar Pollut Bull* 62: 43–47
  162. Schuyler Q, Hardesty B, Wilcox C, Townsend K (2014); Global analysis of anthropogenic debris ingestion by sea turtles. *Conserv Biol* 28: 129–139
  163. Boerger CM, Lattin GL, Moore SL, Moore CJ (2010) Plastic ingestion by planktivorous fishes in the North Pacific Central Gyre. *Mar Pollut Bull* 60: 2275–2278
  164. Possatto FE, Barletta M, Costa M, Ivar do Sul J, Dantas D (2011) Plastic debris ingestion by marine catfish: an un - expected fisheries impact. *Mar Pollut Bull* 62: 1098–1102

165. Ramos J, Barletta M, Costa M (2012) Ingestion of nylon threads by Gerreidae while using a tropical estuary as foraging grounds. *Aquat Biol* 17: 29–34
166. Dantas D, Barletta M, Ramos J, Lima A, Costa M (2013) Seasonal diet shifts and overlap between two sympatric catfishes in an estuarine nursery. *Estuaries Coasts* 36: 237–256
167. Choy CA, Drazen JC (2013) Plastic for dinner? Observations of frequent debris ingestion by pelagic predatory fishes from the central North Pacific. *Mar Ecol Prog Ser* 485:155–163
168. Chiappone M, Dienes H, Swanson DW, Miller SL (2005); Impacts of lost fishing gear on coral reef sessile invertebrates in the Florida Keys National Marine Sanctuary. *Biol Conserv* 121: 221–230
169. Müller C, Townsend K, Matschullat J (2012) Experimental degradation of polymer shopping bags (standard and degradable plastic, and biodegradable) in the gastro-intestinal fluids of sea turtles. *Sci Total Environ* 416:464–467
170. Wright SL, Thompson RC, Galloway TS (2013) The physical impacts of microplastics on marine organisms: a review. *Environ Pollut* 178: 483–492
171. Thompson RC, Olson Y, Mitchell RP, Davis A and others(2004) Lost at sea: Where is all the plastic? *Science* 304:838
172. Browne, M.A., Crump, P., Niven, S.J., Teuten, E., Tonkin, A., Galloway, T., Thompson, R., 2011. Accumulation of microplastic on shorelines worldwide: sources and sinks. *Environ. Sci. Technol.* 45, 9175e9179.
173. Wegner A, Besseling E, Foekema E, Kamermans P, Koelmans A (2012) Effects of nanopolystyrene on the feeding behavior of the blue mussel (*Mytilus edulis* L.). *Environ Toxicol Chem* 31: 2490–2497
174. Besseling E, Wegner A, Foekema EM, Van Den Heuvel- Greve MJ, Koelmans AA (2013) Effects of microplastic on fitness and PCB bioaccumulation by the lugworm *Arenicola marina* (L.). *Environ Sci Technol* 47: 593–600
175. De Mott W (1988) Discrimination between algae and artificial particles by freshwater and marine copepods. *Limnol Oceanogr* 33: 397–408
176. Bern L (1990) Size-related discrimination of nutritive and inert particles by freshwater zooplankton. *J Plankton Res* 12: 1059–1067
177. Cole M, Lindeque P, Fileman E, Halsband C, Goodhead R, Moger J, Galloway TS (2013) Microplastic ingestion by zooplankton. *Environ Sci Technol* 47: 6646–6655
178. Farrell P, Nelson K (2013) Trophic level transfer of micro-plastic: *Mytilus edulis* (L.) to *Carcinus maenas* (L.). *Environ Pollut* 177: 1–3
179. Lavers JL, Bond AL, Hutton I (2014) Plastic ingestion by flesh-footed shearwaters (*Puffinus carneipes*): implications for chick body condition and the accumulation of plastic-derived chemicals. *Environ Pollut* 187: 124–129
180. Lavers JL, Bond AL, Hutton I (2014) Plastic ingestion by flesh-footed shearwaters (*Puffinus carneipes*): implications for chick body condition and the accumulation of

- plastic-derived chemicals. *Environ Pollut* 187: 124–129
181. Tanaka K, Takada H, Yamashita R, Mizukawa K, Fukuwaka MA, Watanuki Y (2013) Accumulation of plastic-derived chemicals in tissues of seabirds ingesting marine plastics. *Mar Pollut Bull* 69: 219–222
  182. Shomura RS, Yoshida HO (eds) (1985) Proceedings of the workshop on the fate and impact of marine debris, 26–29 November 1984, Honolulu, Hawaii. NOAA Tech Memo NMFS-SWFSC 54
  183. Gilardi KVK, Carlson-Bremer D, June JA, Antonelis K, Broadhurst G, Cowan T (2010) Marine species mortality in derelict fishing nets in Puget Sound, WA and the cost/benefits of derelict net removal. *Mar Pollut Bull* 60: 376–382
  184. Allen R, Jarvis D, Sayer S, Mills C (2012) Entanglement of grey seals *Halichoerus grypus* at a haul out site in Cornwall, UK. *Mar Pollut Bull* 64: 2815–2819
  185. Udyawer V, Read MA, Hamann M, Simpfendorfer CA, Heupel MR (2013) First record of sea snake (*Hydrophis elegans*, Hydrophiinae) entrapped in marine debris. *Mar Pollut Bull* 66: 336–338
  186. Wegner NC, Cartamil DP (2012) Effects of prolonged entanglement in discarded fishing gear with substantive biofouling on the health and behavior of an adult shortfin mako shark, *Isurus oxyrinchus*. *Mar Pollut Bull* 64: 391–394
  187. Feldkamp SD (1985) The effects of net entanglement on the drag and power output of a California sea lion, *Zalophus californianus*. *Fish Bull* 83: 692–694
  188. Feldkamp SD, Costa DP, Dekrey GK (1989) Energetic and behavioral effects of net entanglement on juvenile northern fur seals, *Callorhinus ursinus*. *Fish Bull* 87: 85–94
  189. Gregory MR (1991) The hazards of persistent marine pollution— drift plastics and conservation islands. *J R Soc N Z* 21: 83–100
  190. Gregory MR (2009) Environmental implications of plastic debris in marine settings—entanglement, ingestion, smothering, hangers-on, hitch-hiking and alien invasions. *Philos Trans R Soc Lond B Biol Sci* 364: 2013–2025
  191. Henderson JR (2001) A pre- and post-MARPOL Annex V summary of Hawaiian monk seal entanglements and marine debris accumulation in the northwestern Hawaiian Islands, 1982–1998. *Mar Pollut Bull* 42: 584–589
  192. Boland RC, Donohue MJ (2003) Marine debris accumulation in the nearshore marine habitat of the endangered Hawaiian monk seal, *Monachus schauinslandi* 1999– 2001. *Mar Pollut Bull* 46: 1385–1394
  193. Karamanlidis AA, Androukaki E, Adamantopoulou S, Chatzisprou A and others (2008) Assessing accidental entanglement as a threat to the Mediterranean monk seal *Monachus monachus*. *Endang Species Res* 5:205–213
  194. Fowler CW (1987) Marine debris and northern fur seals: a case study. *Mar Pollut Bull* 18: 326–335
  195. Votier SC, Archibald K, Morgan G, Morgan L (2011) The use of plastic debris as

- nesting material by a colonial seabird and associated entanglement mortality. *Mar Pollut Bull* 62: 168–172
196. Hanni KD, Pyle P (2000) Entanglement of pinnipeds in synthetic materials at South-east Farallon Island, California, 1976–1998. *Mar Pollut Bull* 40: 1076–1081
  197. Poon A (2005) Haunted waters: an estimate of ghost fishing of crabs and lobsters by traps. Masters thesis, University of British Columbia, Vancouver
  198. Gunn R, Hardesty BD, Butler J (2010) Tackling ‘ghost nets’: local solutions to a global issue in northern Australia. *Ecol Manage Restor* 11: 88–98
  199. Wilcox C, Hardesty B, Sharples R, Griffin D, Lawson T, Gunn R (2013) Ghost net impacts on globally threatened turtles, a spatial risk analysis for northern Australia. *Conserv Lett* 6: 247–254
  200. Baroth A, Pant Apourv, Sah Ruchika, Hussain Ainul Syed and Chaudhary Pooja (2019), Poster Presentation, Spatiotemporal Trends of Microplastic loading in the Sediments of River Ganga: First Observation on Occurrence, Identification and Quantification SETAC Europe, 29<sup>th</sup> Annual Meeting, 26<sup>th</sup> -30<sup>th</sup> May 2019, Helsinki